

## /// Plug-in railway relay with 7 + 2 gold contacts

Rugged plug-in relays for extreme reliability, within long endurance applications and harsh environments

### CM

Instantaneous relay

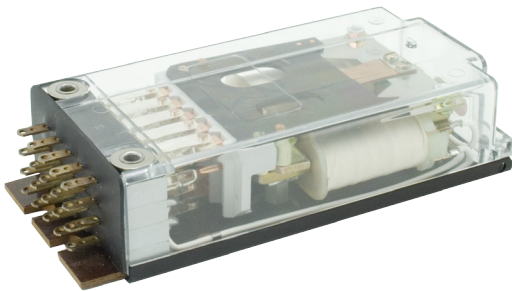

### Description

The CM relay is designed for combined power & dry circuit applications.

The CM relay is configured with 9 double break contacts in all NO and NC combinations with 1 N/C & 1 N/O gold bifurcated contact (dry circuit) and all other in silver.

The CM relays is pluggable in the COR NJ socket.

### Application

The CM relay is designed for both power levels and low level signals are being switched for general purpose heavy duty applications such as lighting, pumps and fans, as standard Weld no transfer design for safety critical applications such as door control, emergency brake failure, interlocking traction and breaking with a gold bifurcated contact for dry circuit signal information

### Features

- Instantaneous relay
- For combined power & dry circuit applications
- 9 double break contacts in all NO and NC combinations with 1 N/C & 1 N/O gold bifurcated contact and all other in silver
- Weld no transfer safety contacts standard on silver contacts
- Contact life (mechanical) of 100 million cycles
- -40 °C...+80 °C operating temperature

### Connection diagram

Example: configuration 4 NC contacts-5 NO contacts

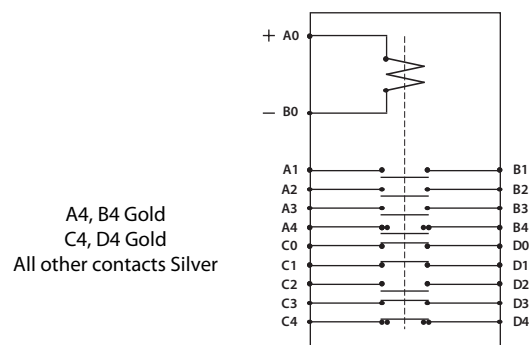

### Timing diagram

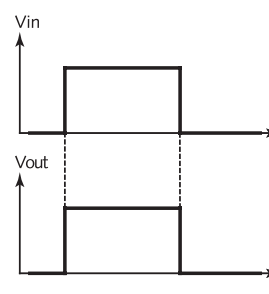

### Railway compliancy

NF F 62-002  
NF F16-101/102  
EN 45445-2

## Instantaneous relay CM

### Dimensions (mm)

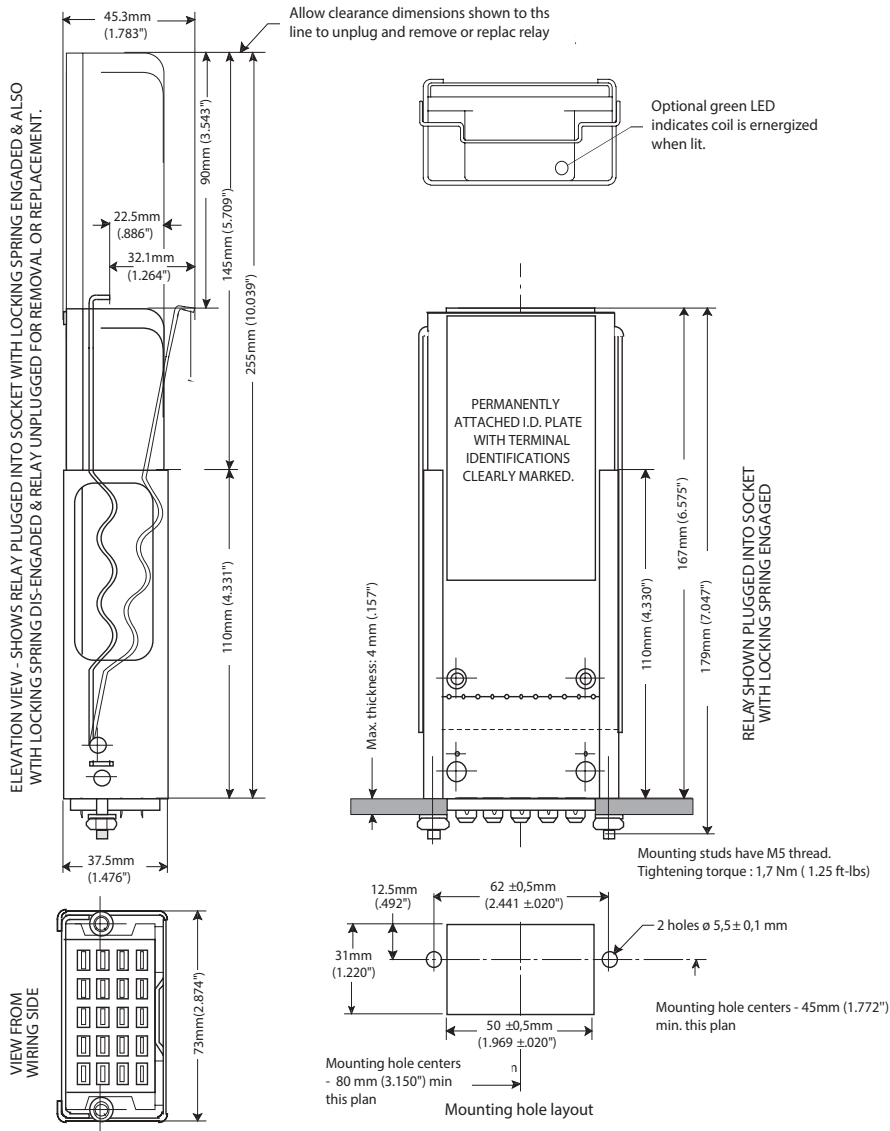

 **Over 10 million Mors Smitt relays in use in rail transport applications worldwide!**

**Mors Smitt Asia Ltd.**  
 Unit B & C, 25/F., Casey Aberdeen House  
 38 Heng Yip Road, Wong Chuk Hang  
 Hong Kong  
 Tel: +852 2343 555  
 sales.msa@wabtec.com

**Mors Smitt France SAS**  
 2 Rue de la Mandinière  
 72300 Sablé-sur-Sarthe, France  
 Tel: +33 (0) 243 92 82 00  
 sales.msfr@wabtec.com

**Mors Smitt UK Ltd.**  
 Graycar Business Park,  
 Burton on Trent, DE13 8EN, UK  
 Tel: +44 (0)1283 357 263  
 sales.msuk@wabtec.com

**Wabtec Netherlands B.V.**  
 Vrieslantlaan 6,  
 3526 AA, Utrecht, Netherlands  
 Tel: +31 (0)30 288 1311  
 sales.msbn@wabtec.com

**Mors Smitt Technologies Ltd.**  
 1010 Johnson Drive,  
 Buffalo Grove, IL 60089-6918, USA  
 Tel: +1 847 777 6497  
 sales.mst@wabtec.com

**RMS Mors Smitt**  
 6 Anzed Court,  
 Mulgrave, VIC 3170, Australia  
 Tel: +61 (0)3 8544 1200  
 sales.rms@wabtec.com

(c) Copyright 2018

All rights reserved. Nothing from this edition may be multiplied, or made public in any form or manner, either electronically, mechanically, by photocopying, recording, or in any manner, without prior written consent from Mors Smitt. This also applies to accompanying drawings and diagrams. Due to a policy of continuous development Mors Smitt reserves the right to alter the equipment specification and description outlined in this datasheet without prior notice and no part of this publication shall be deemed to be part of any contract for the equipment unless specifically referred to as an inclusion within such contract. Mors Smitt does not warrant that any of the information contained herein is complete, accurate, free from potential errors, or fit for any particular purpose. Mors Smitt does not accept any responsibility arising from any party's use of the information in this document.

## Technical specifications

## Instantaneous relay CM

### Coil characteristics - DC versions

U <sub>nom</sub> (VDC)	U <sub>operating</sub> (VDC)	P <sub>nom</sub> (W)	U <sub>hold</sub> (VDC)	U <sub>drop-out</sub> (VDC)	R <sub>coil</sub> (Ω) <sup>1</sup>	L/R (ms) <sup>2</sup>
24	16/33	4.8	13.5	2.5	120	25
36	25/45	4.8	21	3.5	270	25
48	33/60	4.6	28.5	4.5	500	25
70	48/90	5.2	40.5	6.5	1000	25
100	67/125	5	57	9	2000	25
110	77/138	5	60	11.5	4000	25

<sup>1</sup> Coil resistance tol.: ± 8 % at 20 °C

<sup>2</sup> Valid for closed relay

### Coil characteristics - AC versions

U <sub>nom</sub> (VAC)	U <sub>operating</sub> (VAC)	P <sub>nom</sub> (VA)	U <sub>hold</sub> (VAC)	U <sub>drop-out</sub> (VAC)	R <sub>coil</sub> (Ω) <sup>1</sup>	L/R (ms) <sup>2</sup>
220	176/242	4	129	21	12000	25

<sup>1</sup> Coil resistance tol.: ± 8 % at 20 °C

<sup>2</sup> Valid for closed relay

### Contact data - standard version (silver contacts)

Nominal current	8 A resistive		
Nominal breaking capacity and life	2.4 A @ 72 VDC	L/R: 0 ms	Electrical life: 5 x 10 <sup>6</sup> operations
	0.8 A @ 72 VDC	L/R: 30 ms	Electrical life: 2 x 10 <sup>6</sup> operations
	2.4 A @ 220 VAC, 50 hz	Cosφ = 1	Electrical life: 2.5 x 10 <sup>6</sup> operations
	Lamp filament circuit 160 W @ 72 VDC		Electrical life: 5 x 10 <sup>5</sup> operations
Contact overload withstand	@ 24 VDC: 160 A @ L/R = 0 for 10 ms (10 operations at the rate of 1 operations per minute)		
Contact closure	Pick-up time N/O < 45 ms	Drop-out time* N/C < 35 ms	
Contact opening time	Pick-up time N/C < 30 ms	Drop-out time* N/O < 8 ms	
Minimum contact continuity	20 mA @ 24 VDC		
Number of contacts	9 double make / double break contacts (form X&Y)		
Contact material	Hard silver overlay laminated to copper		
Contact resistance, initial	10 mΩ max @ 5A		
Contact resistance, end of life	40 mΩ max @ 5A		

\* With option P less than 70 ms

### Contact data - Gold bifurcated contacts

Contact configuration	Stationary contacts Movable contacts	Bifurcated 2 contact finger design Solid blade
Contact resistance	≤ 20 mΩ @ 5 A (carry only)	
Maximum contact rating	Operating Carry only (no make and break)	20 mA maximum @ 72 VDC 5 mA maximum @ 5 VDC
Minimum current ratings	1 mA @ 5 VDC	
Electrical life	2 x 10 <sup>6</sup> operations	
Contact material	Stationary contacts Movable contacts	Solid gold alloy Gold over hard silver overlay laminated to copper

## Instantaneous relay CM

### Contact design

**Weld no transfer function:**  
If one NO contact welds, no NC contact can close (and visa versa) and cause an overlapping of functions. All relays are factory tested to insure they meet this important safety requirement. 150% of max. operating voltage is applied to the relay while holding 1 NC contact closed by mechanical means. Under these conditions, it is verified that no NO contact makes.

**Double break contacts:**  
Extend the contact life on highly inductive DC currents.

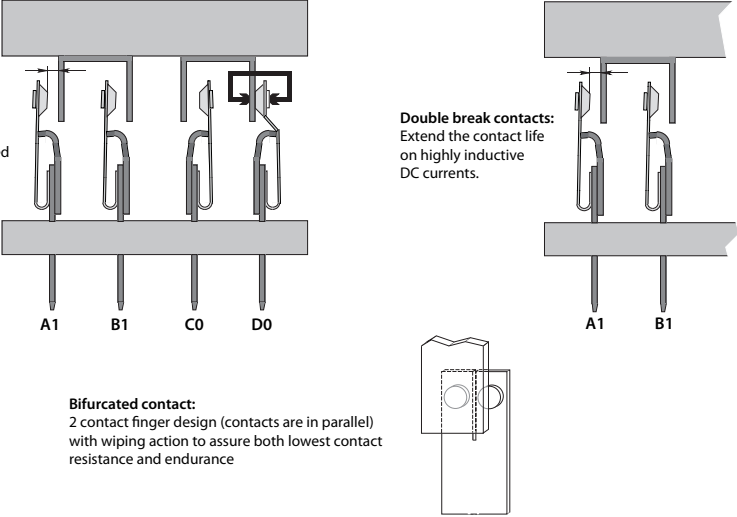

**Bifurcated contact:**  
2 contact finger design (contacts are in parallel) with wiping action to assure both lowest contact resistance and endurance

### Relay pin correspondence

Keying Plate	0	1	2	3	4
A	—	—	—	—	—
B	—	—	—	—	—
C	—	—	—	—	—
D	—	—	—	—	—

Relay pin correspondence (rear view of relay shown)

### Electrical characteristics

Dielectric strength	2000 VAC, 1 min between contacts 2600 VAC, 1 min between contacts, coil and frame
Insulation resistance	≥ 1000 MΩ @ 500 VDC

### Mechanical characteristics

Mechanical life	> 100 x 10 <sup>6</sup> operations
Weight	400 g

## Instantaneous relay CM

### Environmental characteristics

Vibration	NF F 62-002	The tests are conducted in the X, Y, Z planes at frequency between 10 & 150 cycles (sinusoidal) at 2 g
Shock	NF F 62-002	Tests are applied in both directions in the X, Y & Z planes. Then successive shocks are administered consisting of the positive component of sinusoidal with a value of 30 g, 18 ms Other vibration and shock tests can be performed on request.
Operating temperature		-40 °C...+80 °C
Humidity		93% RH, 40 °C for 4 days
Salt mist		5% NaCl, 35 °C for 4 days
Protection		IP40 (relay on socket)
Fire & smoke		Materials: Maktolon polycarbonate (cover) / Polyester (base) These materials have been tested for fire propagation and smoke emission according to standards NF F16-101, NF F16-102, EN 45 545

### Railway compliancy

NF F 62-002	Rolling stock - Instantaneous relays contacts and sockets
NF F16-101/102	Railway rolling stock - Fire behavior
EN 45445-2	Railway applications - Fire protection on railway vehicles Part 2: Requirements for fire behavior of materials and components

# Instantaneous relay CM

## Electrical life expectancy

Dynamic relay selection curve No 1  
(for silver contacts)

AC Current breaking capacity versus life expectancy in millions of cycles.  
Rate of contacts opening and closing = 1200 operations per hour.  
Curves shown for resistive load (Power Factor = 1).

Curve	1	2	3	4
VAC	220	125	48	24

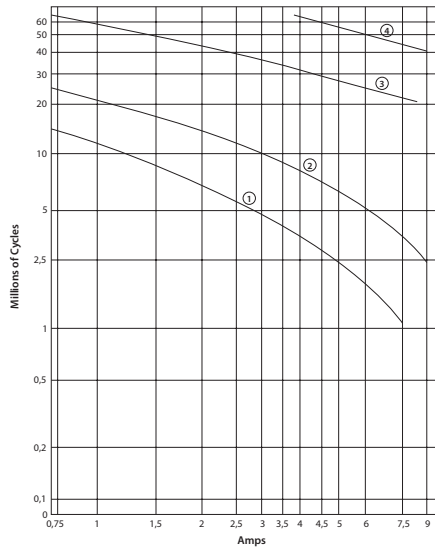

Dynamic relay selection curve No 2  
(for silver contacts)

DC Current breaking capacity versus life expectancy in millions of cycles.  
Rate of contacts opening and closing = 1200 operations per hour.  
Curves shown for inductive load:

— L/R= 20 ms continuous current  
- - - L/R= 40 ms continuous current

Curves	1-3	2-4	5-7	6-8
VDC	220	125	48	24

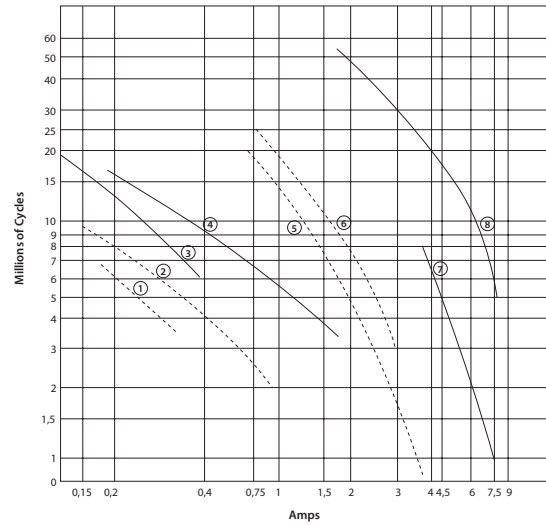

Dynamic relay selection curve No 3  
(for silver contacts)

DC Current breaking capacity versus life expectancy in millions of cycles.  
Rate of contacts opening and closing = 1200 operations per hour.  
Curves shown for resistive load (L/R = 0). Continuous current.

Curve	1	2	3	4
VDC	220	125	48	24

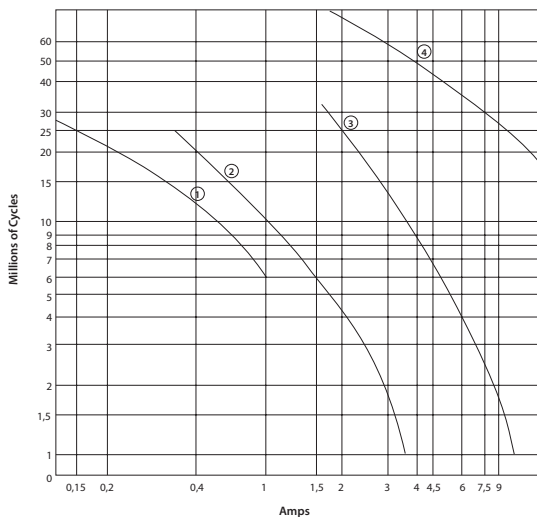

Dynamic relay selection curve No 4  
(for silver contacts)

Maximum contact breaking capacity versus voltage for a given L/R.  
Rate of contacts opening and closing = 600 operations per hour.  
Curves shown for resistive load (L/R=0) and inductive loads. Continuous current.

Curve	1	2	3	4	5	6
L/R=	0ms	15ms	20ms	40ms	60ms	100ms

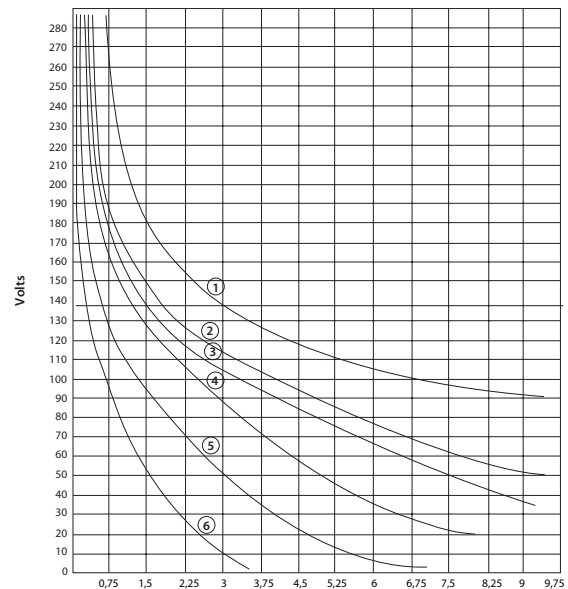

## Instantaneous relay CM

### Electrical life expectancy

Dynamic relay selection curve No 5  
(for silver contacts)

AC Current breaking capacity versus life expectancy in millions of cycles.  
Rate of contacts opening and closing = 1200 operations per hour.

Values shown for inductive loads:

- Cos  $\phi = 0.7$
- - - Cos  $\phi = 0.5$
- Cos  $\phi = 0.3$

Curves	1,3 & 4	2,5 & 7	6,9 & 10	8,11 & 12
VAC	220	125	48	24

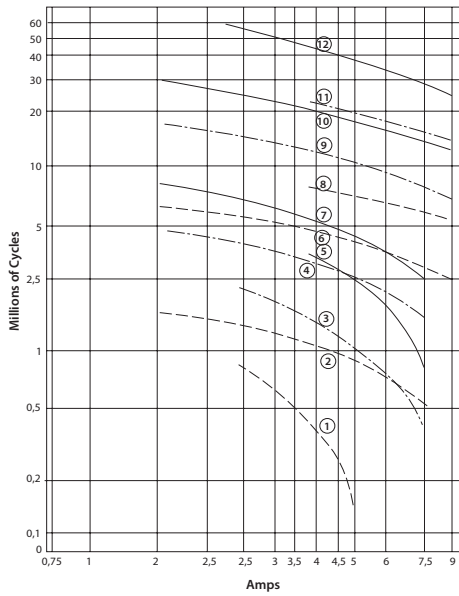

## Instantaneous relay CM

### Mechanical keying

Mechanical keying of the relay to the socket is accomplished during manufacturing.

Keying slots are located by their keying code numbers on the relayboard. Keying rivets are located in the steel socket frame in the correct (and corresponding) coded rivetholes to match with the relay.

Once keying has been completed during manufacturing, it is permanent and cannot be changed. This is intentional in the design to ensure that only the correct relay can be plugged into the socket.

The keying is completed by a color code on the top of the relaycover and on the side of the socket for better identification on the train.

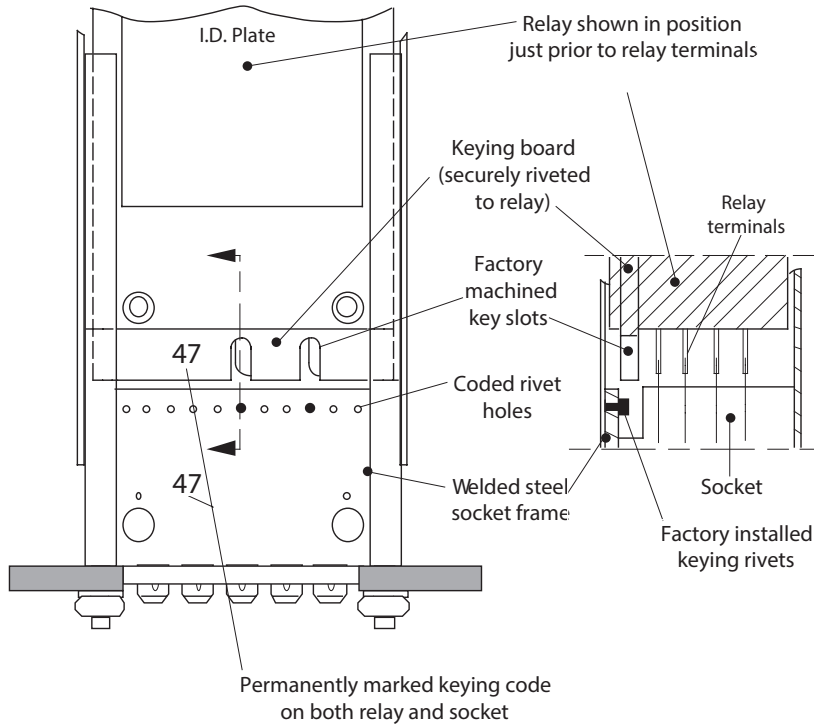



Instantaneous relay  
**CM**

Mounting possibilities/sockets

 <p>COR NJ</p>				
---	--	--	--	--

Panel mounting

926913	COR NJ 37	Socket (Alkyde compound) with locking spring
--------	-----------	--

## Instantaneous relay CM

### Important for relay selection and operation

Make sure the relay is suitable for the application. For critical applications (for example: green loop applications) relays should be checked on correct working during periodic inspection.

### Recommendations for long time contact reliability

For relays to enable failure free performance over a very long operational time, it is important to create the right circumstances. In any relay, contact usage and atmospheric conditions influence the contact surface. To counter this effect it is common practice to use a safety factor of  $> 2$  to ensure long time contact reliability.

Therefore for long time contact reliability we recommend:

- Silver contacts: a minimum contact current of 20 mA per contact
- Gold contacts: a minimum contact current of 10 mA per contact
- Double Make Double Break contacts: a minimum contact current of 40 mA per contact
- When low currents are switched and not frequently, e.g. 10 mA once a day, it is advised next to gold plated contacts to put similar contacts within the same relay in parallel
- Rule of thumb: any relay works best with switching currents  $> 20$  mA in DC environment when frequently switched. When not switched frequently a higher switching current like 50 mA is better for a long reliable operational time
- Check relays regularly and visually through the transparent cover

### Instructions for use

#### Installation

Install socket and connect wiring correctly according identification to terminals. Plug relay into socket. Reverse installation into socket not possible due to mechanical blocking by snap-lock.

Don't reverse polarity of coil connection.

Relays can be mounted (tightly) next to each other and in any attitude. However, we recommend the following:

- - If the relay is mounted vertical; the direction of contact closure should be oriented transverse to the direction of forward motion
- - If the relay is mounted horizontal; the direction of contact closure should be oriented so that gravity will cause the contacts to revert to their de-energised position

Warning! Never use silicon near by relays

#### Operation

Before operating always apply voltage to coil to check correct operation.

Long term storage may corrode the silver on the relay pins. Just by plugging the relay into the socket, the female bifurcated receivers will automatically clean the corrosion on the pins and guarantee a good connection.

Do not use the relay in places with flammable gas as the arc generated from switching could ignite gasses.

#### Inspection / maintenance

Correct operation of relay can easily be checked as transparent cover gives good visibility on the moving contacts. When the relay doesn't seem to operate correct, please check presence of coil voltage. Use a multimeter.

If LED is used, coil presence should be indicated. If coil voltage is present, but the relay doesn't work, a short circuit of suppression diode is possible (The coil connection was reversed). If relay doesn't work after inspection, please replace relay unit by a similar model. Send defective relay back to manufacturer. Normal wear and tear excluded.

Most relay defects are caused by installation faults such as overvoltage, spikes/transients, high/short current far exceeding the relay specifications. When returning the relays for investigation, please provide all information on the RMA form. Send defective relays back to the manufacturer for repair or replacement. Normal wear and tear or external causes are excluded from warranty.

RMA procedure see [www.morssmitt.com](http://www.morssmitt.com)

## Instantaneous relay CM

### Ordering scheme

CM	0								
Contact configuration	0 to 9								N/C contact, with 1 N/C gold bifurcated contact C4 - D4 contact
		0 to 9							N/O contact, with 1 N/O gold bifurcated contact A4 - B4 contact
Nominal voltage			24						
			36						
			48						
			72						
			100						
			110						
Keying code									Will be set up by Mors Smitt
Coil overvoltage protection						-			No coil protection
						P			Avalanche diode coil protection
						S			Transil coil protection
LED coil voltage indicator								-	No LED
								V	LED voltage indicator

#### Notes:

- Total of contacts: 9
- Contact allocation other than A4 - B4, C4 - D4 for gold bifurcated, on demand
- For more than 2 gold bifurcated, on demand

Example: CM 045 72 37

Description: CM relay, 0 C/O contacts, 4 N/C contacts, 5 N/O contacts, nominal voltage 72, keying code 37, no coil protection, no LED

**Instantaneous relay**  
**CM**

---

 **Over 10 million Mors Smitt relays in use in rail transport applications worldwide!**

**Mors Smitt Asia Ltd.**  
Unit B & C, 25/F., Casey Aberdeen House  
38 Heng Yip Road, Wong Chuk Hang  
Hong Kong  
Tel: +852 2343 555  
sales.msa@wabtec.com

**Mors Smitt France SAS**  
2 Rue de la Mandinière  
72300 Sablé-sur-Sarthe, France  
Tel: +33 (0) 243 92 82 00  
sales.msf@wabtec.com

**Mors Smitt UK Ltd.**  
Graycar Business Park,  
Burton on Trent, DE13 8EN, UK  
Tel: +44 (0)1283 357 263  
sales.msuk@wabtec.com

**Wabtec Netherlands B.V.**  
Vrieslantlaan 6,  
3526 AA, Utrecht, Netherlands  
Tel: +31 (0)30 288 1311  
sales.msbv@wabtec.com

**Mors Smitt Technologies Ltd.**  
1010 Johnson Drive,  
Buffalo Grove, IL 60089-6918, USA  
Tel: +1 847 777 6497  
salesmst@wabtec.com

**RMS Mors Smitt**  
6 Anzed Court,  
Mulgrave, VIC 3170, Australia  
Tel: +61 (0)3 8544 1200  
sales.rms@wabtec.com

(c) Copyright 2018

All rights reserved. Nothing from this edition may be multiplied, or made public in any form or manner, either electronically, mechanically, by photocopying, recording, or in any manner, without prior written consent from Mors Smitt. This also applies to accompanying drawings and diagrams. Due to a policy of continuous development Mors Smitt reserves the right to alter the equipment specification and description outlined in this datasheet without prior notice and no part of this publication shall be deemed to be part of any contract for the equipment unless specifically referred to as an inclusion within such contract. Mors Smitt does not warrant that any of the information contained herein is complete, accurate, free from potential errors, or fit for any particular purpose. Mors Smitt does not accept any responsibility arising from any party's use of the information in this document.