

/// GR Circuit breaker, hydraulic magnetic, 35 mm rail

Rugged plug-in relays for extreme reliability, within long endurance applications and harsh environments

GR Circuit breaker

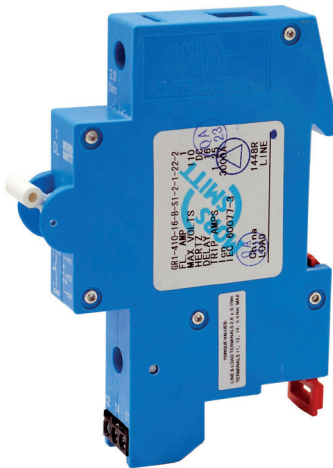

Description

Compact hydraulic magnetic circuit breaker for railway applications, to protect electronic equipment and components against unintended high currents. Optional with integrated auxiliary contacts to monitor the circuit.

The trip point is always at maximum allowable current, independent of ambient temperature. Mid-trip handle to indicate clearly a breaker operation caused by electrical fault. With unique arc chute design which results in high interrupting capacities. Integrated 35 mm rail connection for easy and quick mounting on 35 mm rails. Wide range of currents and options available.

Application

GR circuit breakers are used in every application where electrical systems, circuits or components must be protected against too high currents. This situation can occur, when under strained or heavy use a motor or other load-generating component within the equipment will draw additional current from the power source. High currents cause the wires or components to overheat and ultimately burn up.

A circuit protection device should be employed at any point where a conductor size changes. Many electronic circuits and components like transformers have a lower overload withstand threshold level than conductors such as wires and cables. These components require circuit protection devices featuring very fast overload sensing and opening capabilities.

GR circuit breakers can be used in all railway applications where protection against overload and short circuit is necessary, for example HVAC systems, (door) control systems, braking systems, passenger information systems, etc.

Features

- Precise, temperature independent operation
- 35 mm rail mount
- Integrated auxiliary contacts with screw terminals or internal connector (optional)
- Up to 4 poles configuration
- High interrupting capacities due to unique arc chute method
- Mid-trip handle for electrical trip indication (optional)
- Immediate resetting possible
- Wide current range: 0.2 - 63 A
- Wide choice of time delays
- Maximum voltage 137.5 VDC / 484 VAC
- High contact pressure & longer contact life due to wiping self-cleaning contacts

Busbar

Example configuration of GR and CR circuitbreakers including busbar.

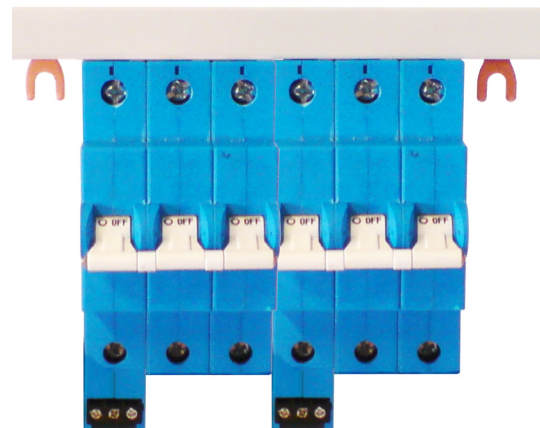

Railway compliancy

EN 50155	NF F16-101/102
IEC 60077 - 1/2/3/4	NF F 62-001 - 1/2/3
IEC 61373	NF F61-010
EN 50124-1	IEC 60068-2-30
EN 45545-2	IEC 60068-2-52
IEC 60947-2	MIL-STD-202G Method 107D, condition A
	MIL-STD-202G Method 106D

Technical specifications
Electrical characteristics

Application voltage	DC for 1-4 poles	AC for 1-2 poles	AC for 3-4 poles
Rated voltage	12 - 110 VDC	12 - 240 VAC	12 - 440 VAC
Min. operating voltage	8.4 VDC	10.8 VAC	10.8 VAC
Max. operating voltage	137.5 VDC	264 VAC	484 VAC
Current ratings	0.2 – 63 A. The GR circuit breaker is polarity insensitive. (except single pole DC breaker)		
Dielectric strength	3000 VAC, 50/60 Hz for 1 minute between all electrically isolated terminals.		
Creepage and clearance	EN 50124-1 8 mm spacing requirements from hazardous voltage to operator accessible surfaces, between adjacent poles and from main circuits to auxiliary circuits.		
Insulation resistance	Minimum of 100 MΩ @ 500 VDC		
Operating frequency	16 ^{2/3} / 50 / 60 Hz, DC		
Overload	12 operations at 600% of the rated current AC, 250% DC per IEC 60947-2		
Max. interrupting cap.	IEC 60077	3000 A @ 137.5 VDC, 63 A (1-pole) 5000 A @ 137.5 VDC, 63 A (2-pole) 5000 A @ 264 VAC, 63 A (1- or 2-pole) 4000 A @ 484 VAC, 63 A (3- or 4-pole)	
	IEC 60947-2	10000 A @ 63 VDC, 63 A (1-pole) 2500 A @ 116 VDC, 63 A (1-pole) 8200 A @ 116 VDC, 63 A (2-pole) 5000 A @ 252 VAC, 63 A (1-pole) 4000 A @ 462 VAC, 63 A (3- or 4-pole) 4000 A @ 572 VAC, 10 A (2-pole)	
	UL 1077	10000 A @ 110 VDC, 40 A (1-pole)	
Auxiliary switch	Integrated, load side. SPST. Auxiliary switch senses the on-off position of circuit breaker handle, as well as the open-closed position of breaker contact.		
		Silver auxiliary contacts	Gold auxiliary contacts
AC min. switching cap.		5 - 20 VAC: 100 mA ≥ 20 VAC: 10 mA	5 mA / 5 VAC
AC max. switching cap.		5 A / 125 VAC	100 mA / 125 VAC
DC min switching cap.		≤ 20 VDC: 100 mA ≥ 20 VDC: 10 mA	5 mA / 5 VDC
DC max. switching cap.		3 A / 32 VDC 100 mA / 125 VDC (max. 2000 cycles)	100 mA / 32 VDC 2 mA / 110 VDC (max. 2000 cycles)
	All loads mentioned are resistive loads.		

Circuit breaker GR

General characteristics

Number of poles	1, 2, 3 or 4 poles	
Terminals	<p>Line terminal</p> <p>Minimum wire size</p> <p>Maximum wire size</p> <p>Busbar/tab connection thickness range</p> <p>Load terminal</p> <p>Minimum wire size</p> <p>Maximum wire size</p> <p>Busbar/tab connection thickness range:</p> <p>Wires of different cross sectional area in one terminal is not recommended. 2 wires of identical cross sectional area in one terminal is possible with restrictions. Contact Mors Smitt for more information.</p> <p>Torque value (line & load)</p>	<p>dual connection, see form & fit drawings</p> <p>1.0 mm²</p> <p>9.0 x 9.0 mm</p> <p>1.19 ~ 1.57 mm (0.047 ~ 0.062 inches)</p> <p>See form & fit drawings</p> <p>1.0 mm²</p> <p>8.7 x 6.5 mm</p> <p>1.19 ~ 1.57 mm (0.047 ~ 0.062 inches)</p> <p>Nominal 2.8 Nm with tool tolerance +/- 0.1 Nm, maximum 2.9 Nm</p>
Auxiliary contacts	<p>Captive screws</p> <p>Minimum wire size</p> <p>Maximum wire size</p> <p>Maximum torque value</p> <p>Wire strip length: 5.5 mm</p> <p>Internal connector</p>	<p>0.2 mm²</p> <p>1.5 mm²</p> <p>0.4 Nm</p> <p>5.5 mm</p> <p>See page 6</p>
Mounting	<p>35 mm rail lock is located at bottom of circuit breaker (load terminal side) when mounted vertically (wall mount position). The hydraulic-magnetic circuit breakers of Mors Smitt can be mounted in any position. A hydraulic-magnetic breaker is designed to "must hold" at 100% of the breaker's current rating and is calibrated to "must trip" at 125% of the breaker's current rating. If the mounting position is +90 degrees from a vertical panel mount (handle facing down, ceiling mount position) the trip and must hold rating is reduced by 10%.</p>	
Body	Blue colour	
Actuator	Handle, white or black with "I O" and/or "On-off" legends	
Int. circuit configuration	Series trip & switch only	
Weight	<p>1-pole without aux. contact</p> <p>2-pole without aux. contact</p> <p>3-pole without aux. contact</p> <p>4-pole without aux. contact</p> <p>1-pole with aux. contact</p> <p>2-pole with aux. contact</p> <p>3-pole with aux. contact</p> <p>4-pole with aux. contact</p>	<p>135 g</p> <p>270 g</p> <p>405 g</p> <p>540 g</p> <p>140 g</p> <p>275 g</p> <p>410 g</p> <p>545 g</p>
Width per pole	17.5 mm	
Material	<p>Half shell - BMC 605</p> <p>Handle - Valox 420SEO UL94V0</p> <p>Terminals - Brass with acid tin plate</p>	<p>(weight per pole ~ 69.4 g)</p> <p>(weight per pole ~ 1.2 g)</p>

Circuit breaker GR

Mechanical characteristics

Endurance	10.000 "On-Off" operations with rated current & voltage.
Trip free mechanism	Trips on short-circuit or on overload, even when actuator is forcibly held in the "On" position.
Mid trip indication	The operating handle moves positively to the mid position and an auxiliary switch is actuated, when an overload or a short circuit causes the circuit breaker to trip. Remark: It is possible to manually switch the circuit breaker to the mid-trip position when the handle is switched from OFF to ON position quickly and with strong upwards force. Normally this won't occur in standard use. This is a normal phenomenon related to the design of the product.

Environmental characteristics

Environmental	Complies to EN 50125-1 and IEC 60077-1
Operating temperature	-50 °C...+85 °C
Vibration	IEC 61373, Category 1, class B body mounted
Shock	IEC 61373, Category 1, class A & B body mounted
Thermal shock	Complies to MIL-STD 202G method 107D, test condition A
Salt mist	Complies to IEC 60068-2-52 severity level 3
Damp heat	Complies to IEC 60068-2-30 test method Db variant 1
Fire & smoke	Complies to NF F 16101, NF F 16102, EN 45545-2
Protection	IEC 60529, IP40 when a panel is mounted over the circuit breaker; when no panel is mounted IP20
Moisture resistance / humidity	Complies to MIL-STD 202G method 106D

Railway compliancy

EN 50155	Railway applications - Rolling stock - Electronic equipment
IEC 60077 - 1/2/3/4	
IEC 61373	Railway applications - Rolling stock equipment - Shock and vibration tests
EN 50124-1	
EN 45545-2	Railway applications - Fire protection on railway vehicles Part 2: Requirements for fire behavior of materials and components
NF F16-101/102	Railway rolling stock - Fire behavior
NF F62-001 - 1/2/3	
NF F61-010	
IEC 60068-2-30	
IEC 60068-2-52	
IEC 60947-2	
MIL-STD-202G Method 107D, condition A	
MIL-STD-202G Method 106D	

Resistance, impedance

Resistance, impedance values from Line to Load terminals
(Values based on series trip circuit breaker)

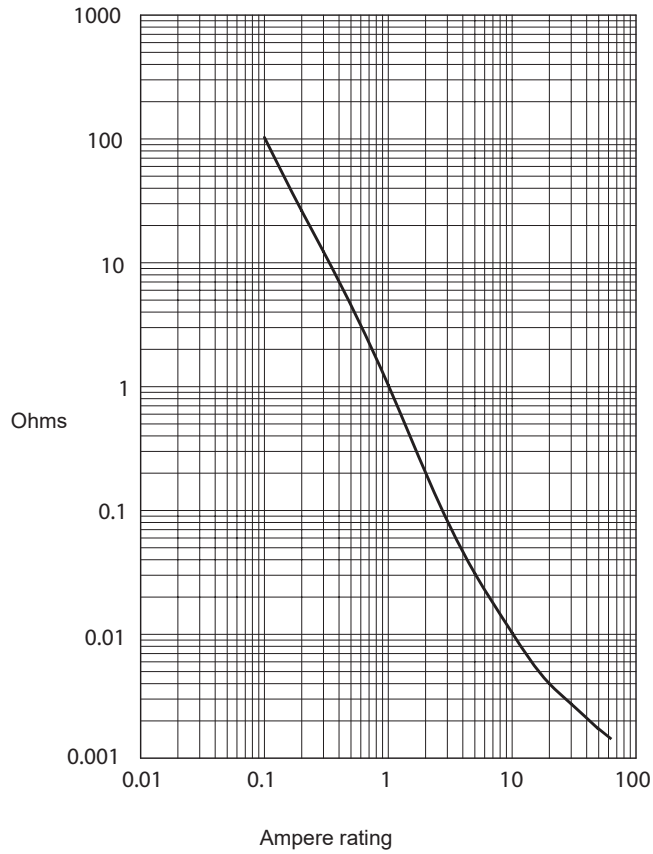

Current (amps)	Tolerance (%)
0.10 - 5.0	± 15%
5.1 - 20.0	± 25 %
20.1 - 63.0	± 35 %

Circuit breaker GR

Auxiliary contact with internal connector

The GR circuit breaker with auxiliary contact with internal connector has no screw terminals but a (male) Phoenix Combicon connector inside. Wires can be connected to a (female) plug, which can easily be connected into the circuit breaker.

Advantages:

- Pre-wiring is possible
- Easy interchangeable
- Time saving solution
- Various connection methods possible
- Many different plugs available, for example spring clamp terminals, screw terminals, terminals under different angles or position, with or without integrated test points, etc.



Internal connector

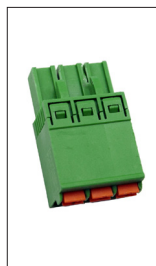

Plug with spring clamp terminals

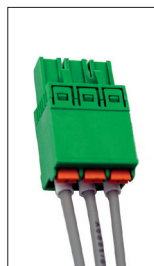

Plug with wires connected

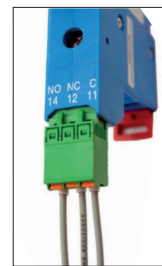

GR circuit breaker with plug and wires connected

Example plugs

Spring clamp terminals

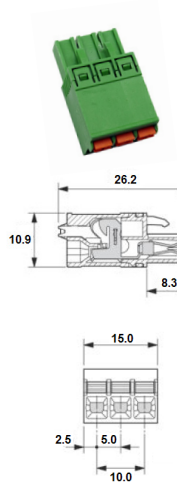

Screw terminals
45° angle

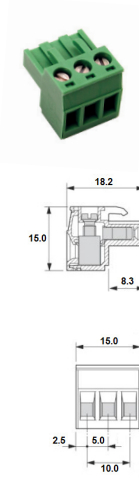

Screw terminals

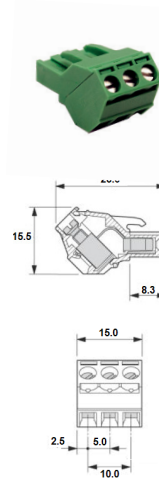

Dimensions in mm

Wire size solid wire	0.2 - 1.5 mm ²	0.2 - 2.5 mm ²	0.2 - 2.5 mm ²
Wire size stranded wire	0.2 - 2.5 mm ²	0.2 - 2.5 mm ²	0.2 - 2.5 mm ²
Wire size stranded wire with ferrule	0.25 - 1.5 mm ²	0.25 - 2.5 mm ²	0.25 - 2.5 mm ²
Wire stripping length	10 mm	7 mm	7 mm

The auxiliary contact with internal connector can be used with accompanying Phoenix Combicon plugs.

Phoenix item number internal connector: 1753453.

The circuit breaker is standard delivered without plugs.

Circuit breaker GR

GR circuit breaker with diode inside auxiliary contac

If there are several circuit breakers connected to one I/O card, the diode in the auxiliary contacts makes it possible to detect which circuit breaker has tripped. This can reduce the number of I/O cards.

Type of diode: 1N4007

Auxiliary contact schematic

Screw terminals

Internal connector

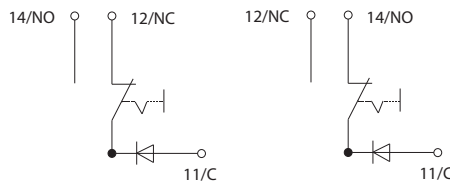

Connection example (screw terminals)

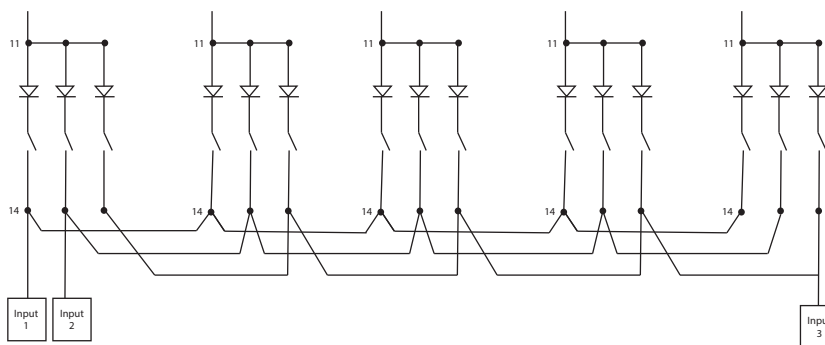

Table of time delay values

TRIP TIME (SECONDS)	PERCENT OF RATED CURRENT										
	DELAY	100%	125%	135%	150%	200%	400%	600%	800%	1000%	1200%
10	No Trip	May Trip	---	.032 MAX	.024 MAX	.020 MAX	.018 MAX	.016 MAX	.015 MAX	.013 MAX	
11	No Trip	.013 - .125	---	.010 - .070	.008 - .032	.006 - .020	.005 - .020	.004 - .020	.004 - .020	.004 - .020	
12	No Trip	.500 - 6.50	---	.300 - 3.00	.130 - 1.20	.031 - .220	.011 - .120	.004 - .090	.004 - .060	.004 - .040	
14	No Trip	2.00 - 60.0	---	1.20 - 40.0	.600 - 20.0	.150 - 3.00	.030 - 1.30	.004 - .600	.004 - .100	.004 - .100	
16	No Trip	45.0 - 345	---	20.0 - 150	9.00 - 60.0	1.40 - 11.4	.150 - 5.80	.009 - 3.70	.005 - 1.70	.005 - .500	
20	No Trip	May Trip	---	.040 MAX	.035 MAX	.030 MAX	.025 MAX	.020 MAX	.017 MAX	.015 MAX	
21	No Trip	.014 - .150	---	.011 - .095	.008 - .055	.006 - .035	.005 - .027	.005 - .021	.004 - .018	.004 - .017	
22	No Trip	.700 - 12.0	---	.350 - 4.00	.130 - 1.30	.027 - .220	.008 - .130	.004 - .090	.004 - .045	.004 - .040	
24	No Trip	10.0 - 160	---	6.00 - 60.0	2.20 - 20.0	.300 - 3.00	.050 - 1.30	.007 - .500	.005 - .060	.005 - .040	
26	No Trip	50.0 - 700	---	32.0 - 350	10.0 - 90.0	1.50 - 15.0	.500 - 7.00	.020 - 3.00	.006 - 2.00	.005 - 1.00	
42	No Trip	.700 - 12.0	---	.400 - 6.00	.180 - 2.30	.050 - .600	.026 - .300	.018 - .200	.014 - .150	.012 - .130	
44	No Trip	7.00 - 100	---	3.00 - 50.0	1.10 - 18.0	.220 - 3.00	.120 - 1.70	.075 - 1.20	.050 - .850	.042 - .720	
46	No Trip	50.0 - 700	---	31.0 - 350	12.0 - 150	1.50 - 20.0	.700 - 10.0	.404 - 7.90	.260 - 6.50	.198 - 5.80	
52	No Trip	.500 - 6.50	---	.340 - 4.50	.180 - 2.30	.051 - .600	.030 - .320	.018 - .220	.014 - .200	.012 - .130	
54	No Trip	1.50 - 50.0	---	.750 - 35.0	.350 - 18.0	.110 - 3.00	.070 - 1.70	.045 - 1.40	.039 - 1.30	.035 - 1.30	
56	No Trip	45.0 - 345	---	19.0 - 170	8.50 - 100	1.24 - 15.0	.410 - 9.00	.256 - 8.00	.210 - 5.50	.198 - 2.90	

Notes:

- Delay curves 11, 12, 14, 16, 21, 22, 24, 26, 42, 44, 46, 52, 54, 56: Breakers to hold 100% and must trip at 125% of rated current and greater within the time limit shown in this curve
- Delay curves 10, 20: Breakers to hold 100% and must trip at 150% of rated current and greater within the time limit shown in this curve
- All curves: Curve data shown represents breaker response at ambient temperature of 25 °C (77 °F) with no preloading. Breakers are mounted in standard wall-mount position. Delay times may vary at different temperature, the trip current rating remains unchanged
- On 50 amp and less current ratings, the minimum inrush pulse tolerance handling capability is 12 times the rated current on standard delays and 25 times the rated current on high inrush delays. These values are based on a 60 Hz 1/2 cycle, 8.33 ms pulse. High inrush delays should be specified for applications with high initial surge currents of short duration such as switching power supplies, highly capacitive loads and transformer loads

Circuit breaker GR

Time delay values

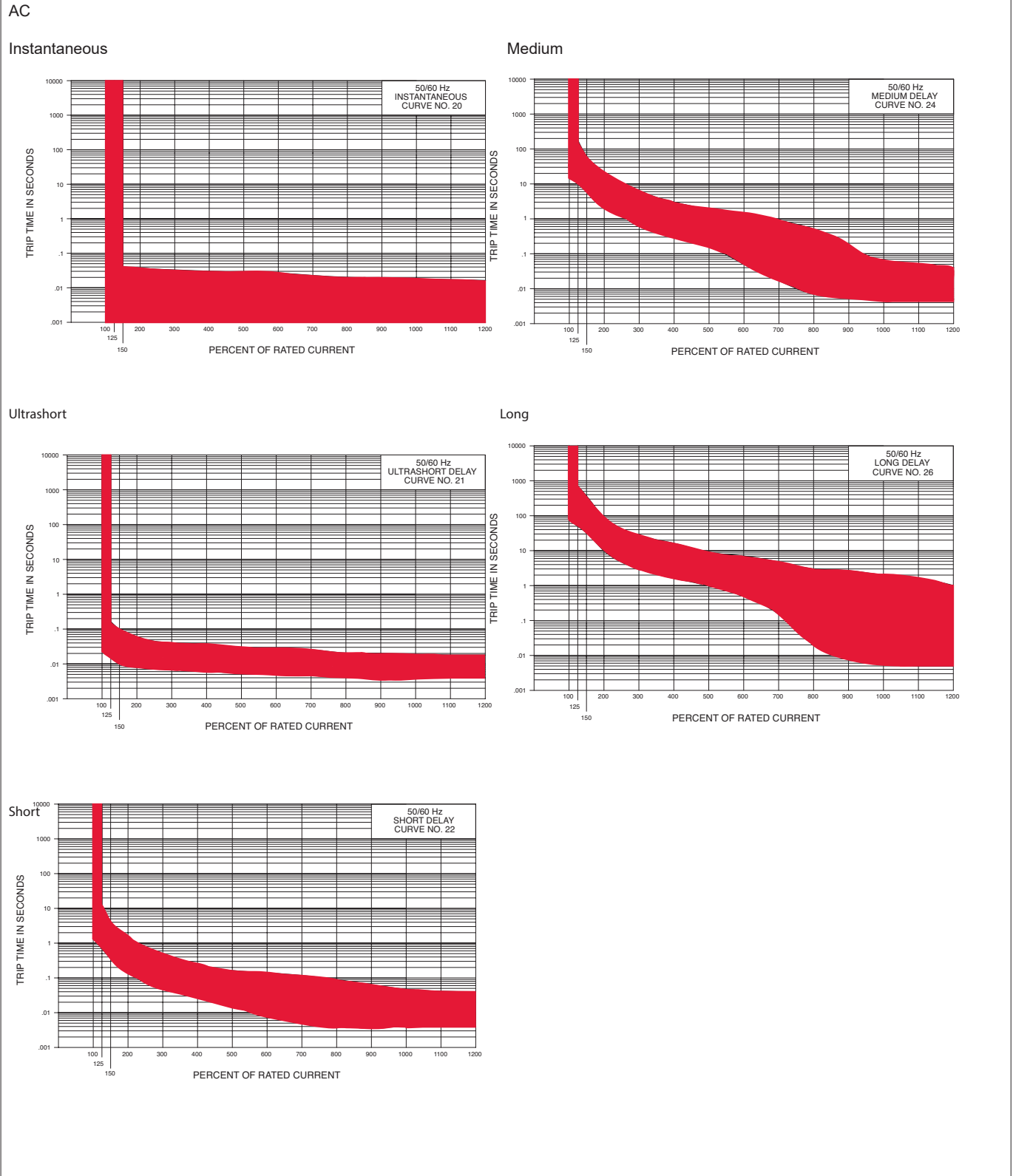

Circuit breaker GR

Time delay values

High Inrush AC

Short

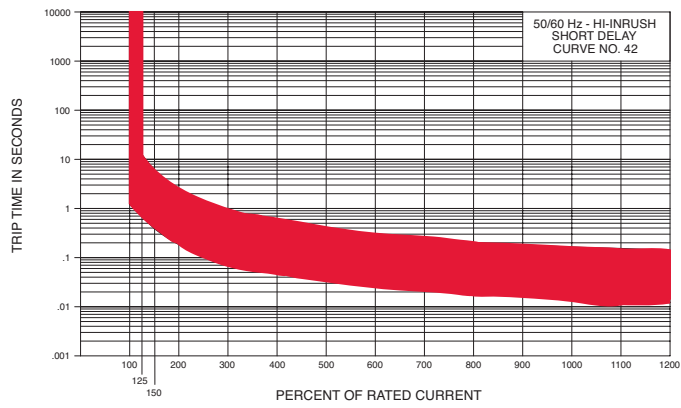

Medium

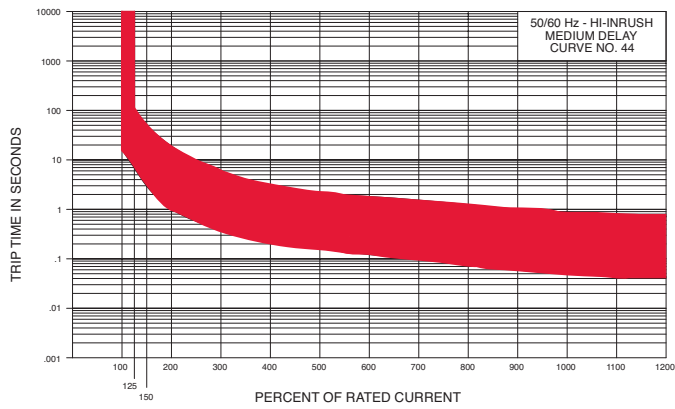

Long

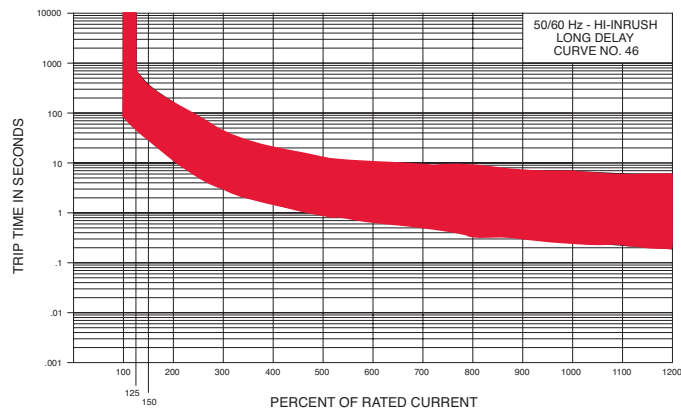

Circuit breaker GR

Time delay values

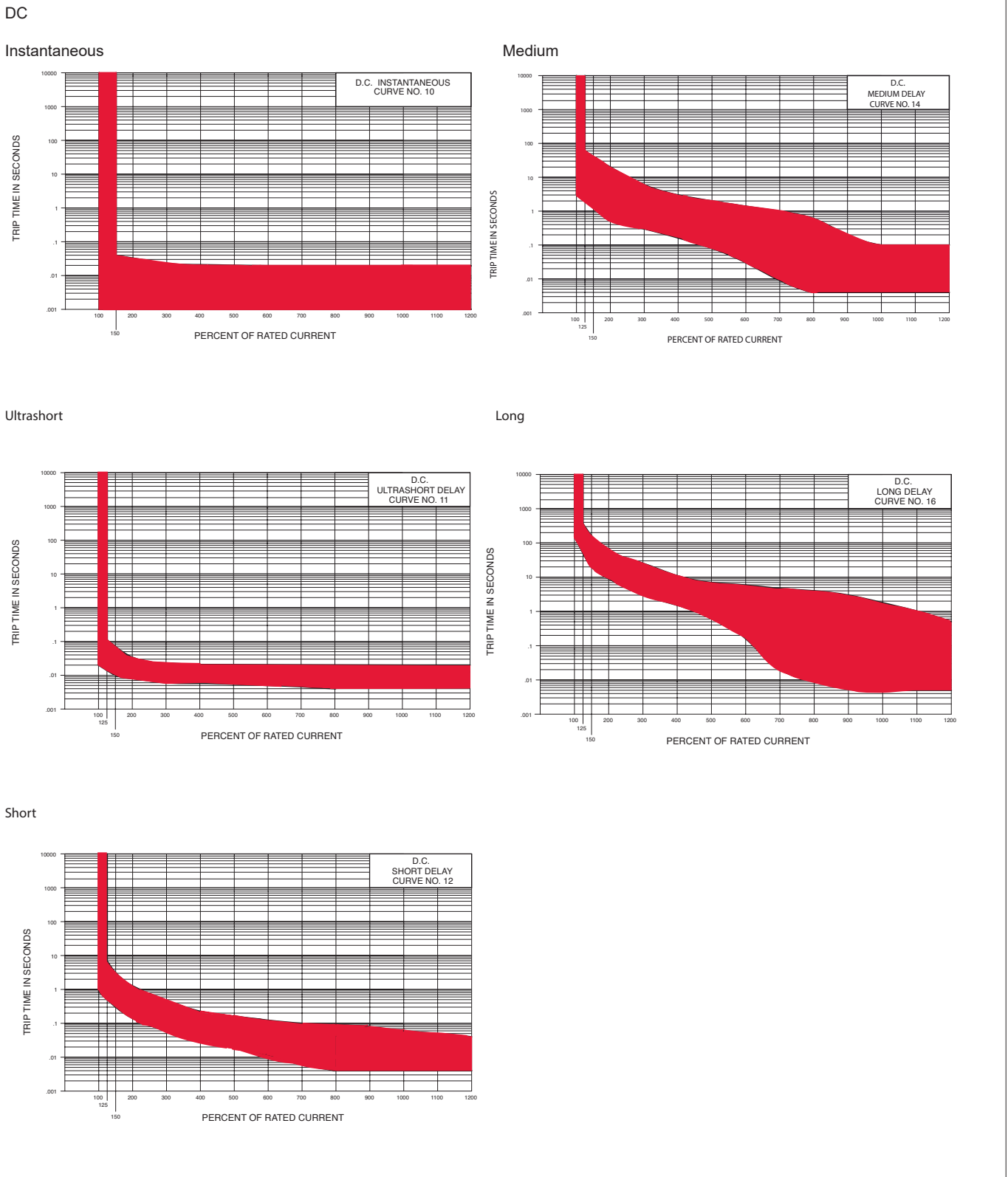

Circuit breaker GR

Time delay values

High Inrush DC

Short

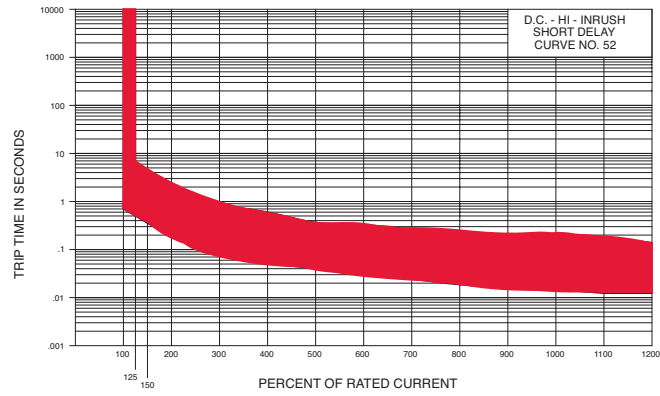

Medium

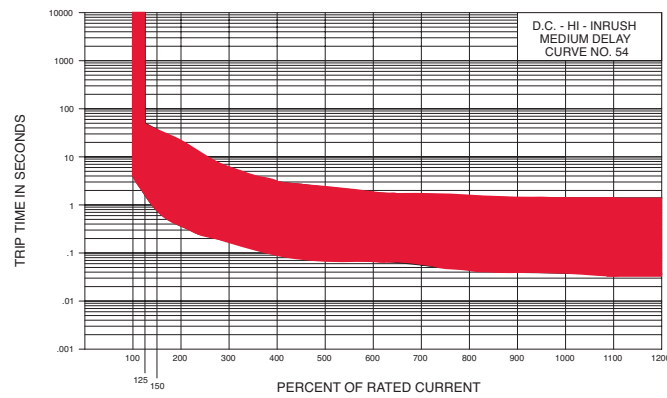

Long

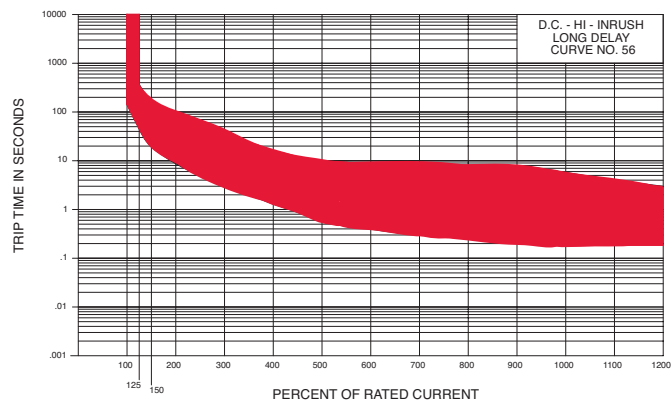

Circuit breaker GR

Form & fit drawings

GR 1 pole without auxiliary switch

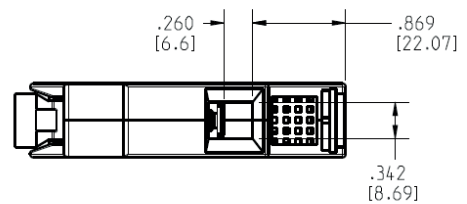
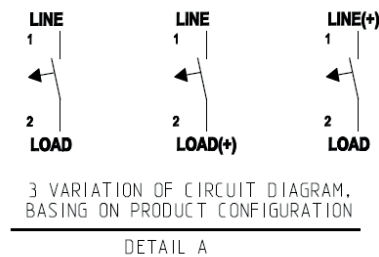
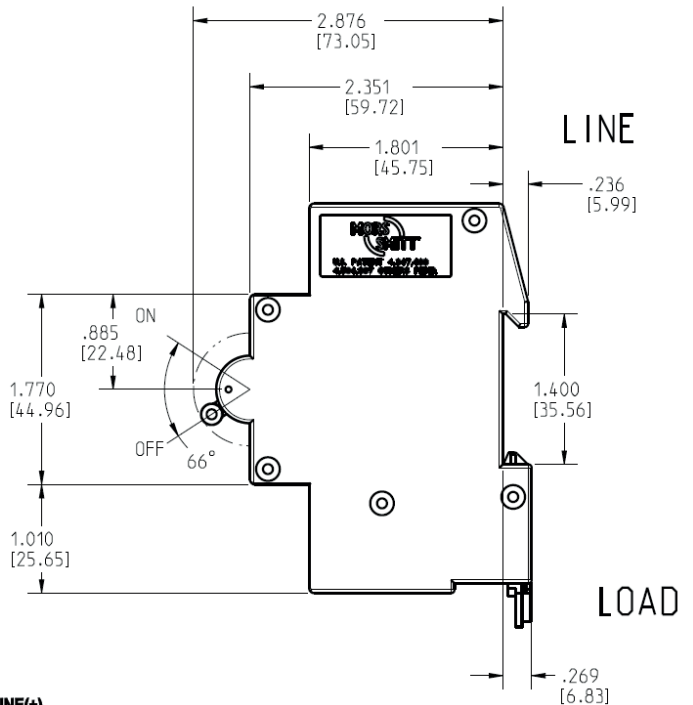
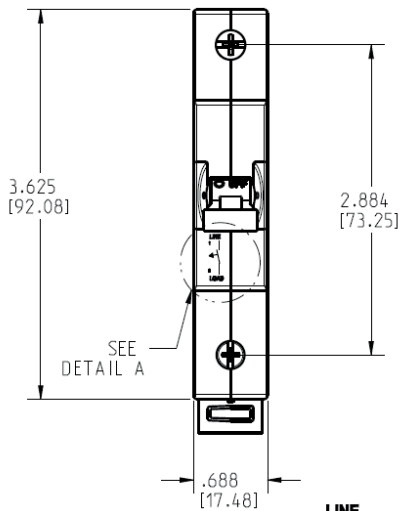
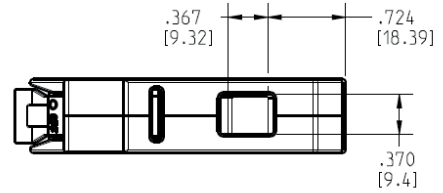
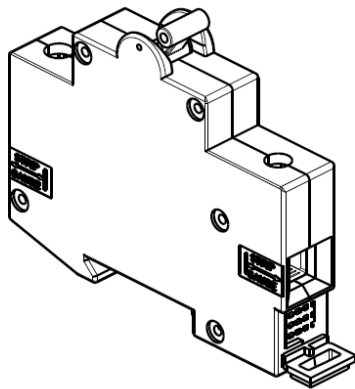

- Notes:
1. All dimensions are in inches [millimeters]
 2. Tolerance ± 0.01 [0.25] unless otherwise specified
 3. Angles $\pm 1^\circ$

Circuit breaker GR

Form & fit drawings

GR 1 pole with auxiliary switch (screw terminals)

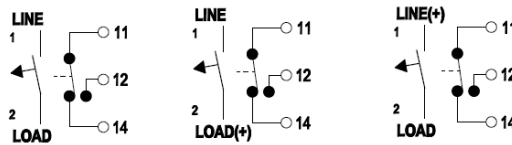
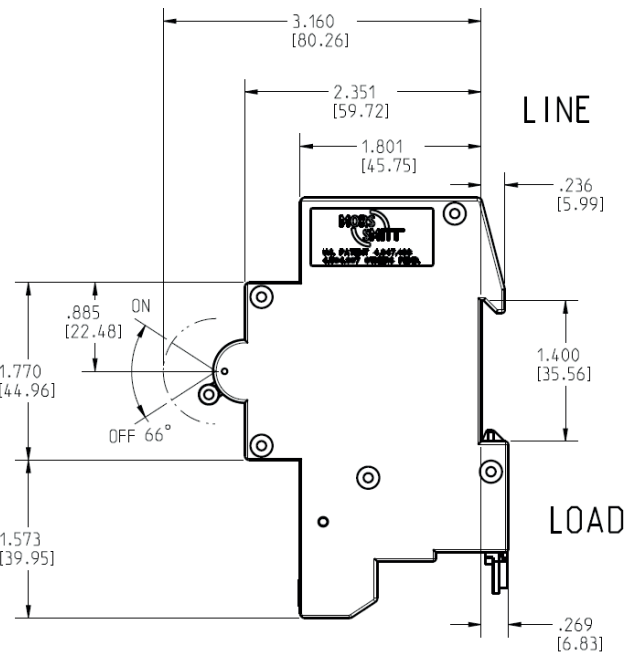
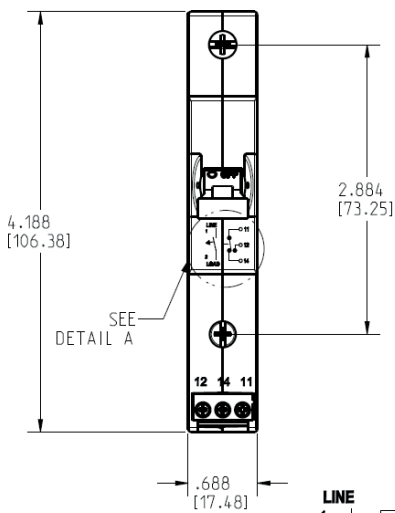
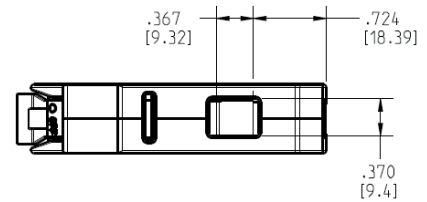
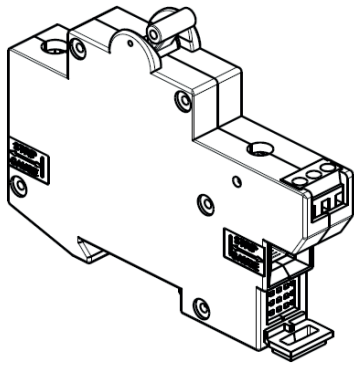

3 VARIATION OF CIRCUIT DIAGRAM,
BASING ON PRODUCT CONFIGURATION

DETAIL A

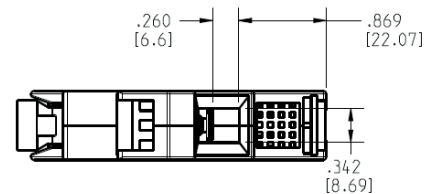

- Notes:
1. All dimensions are in inches [millimeters]
 2. Tolerance ± 0.01 [0.25] unless otherwise specified
 3. Angles $\pm 1^\circ$

Circuit breaker GR

Form & fit drawings

GR 1 pole with auxiliary switch (internal connector)

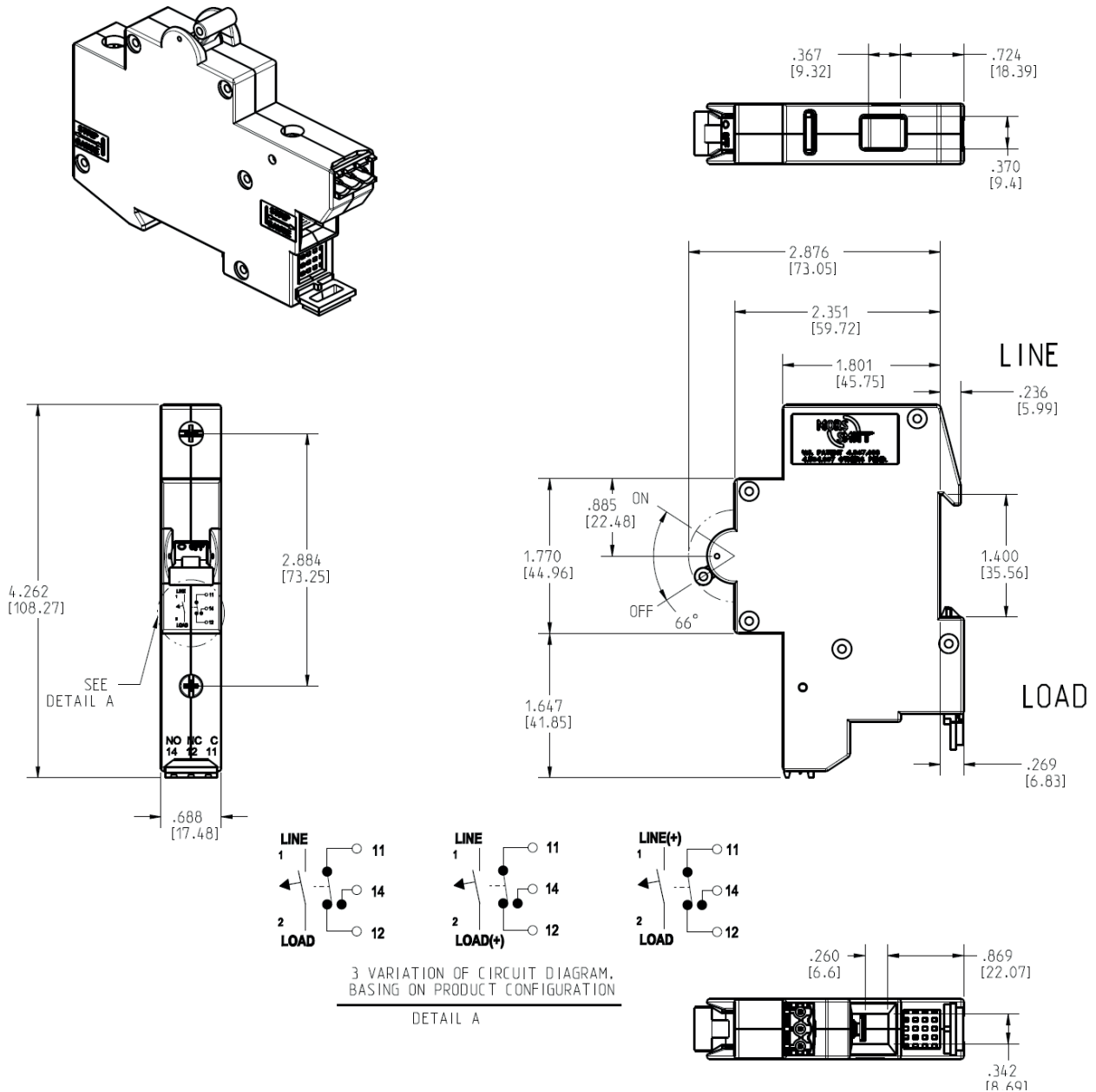

- Notes:
1. All dimensions are in inches [millimeters]
 2. Tolerance ± 0.01 [0.25] unless otherwise specified
 3. Angles $\pm 1^\circ$

Circuit breaker GR

Form & fit drawings

GR 2 poles with auxiliary switch (screw terminals)

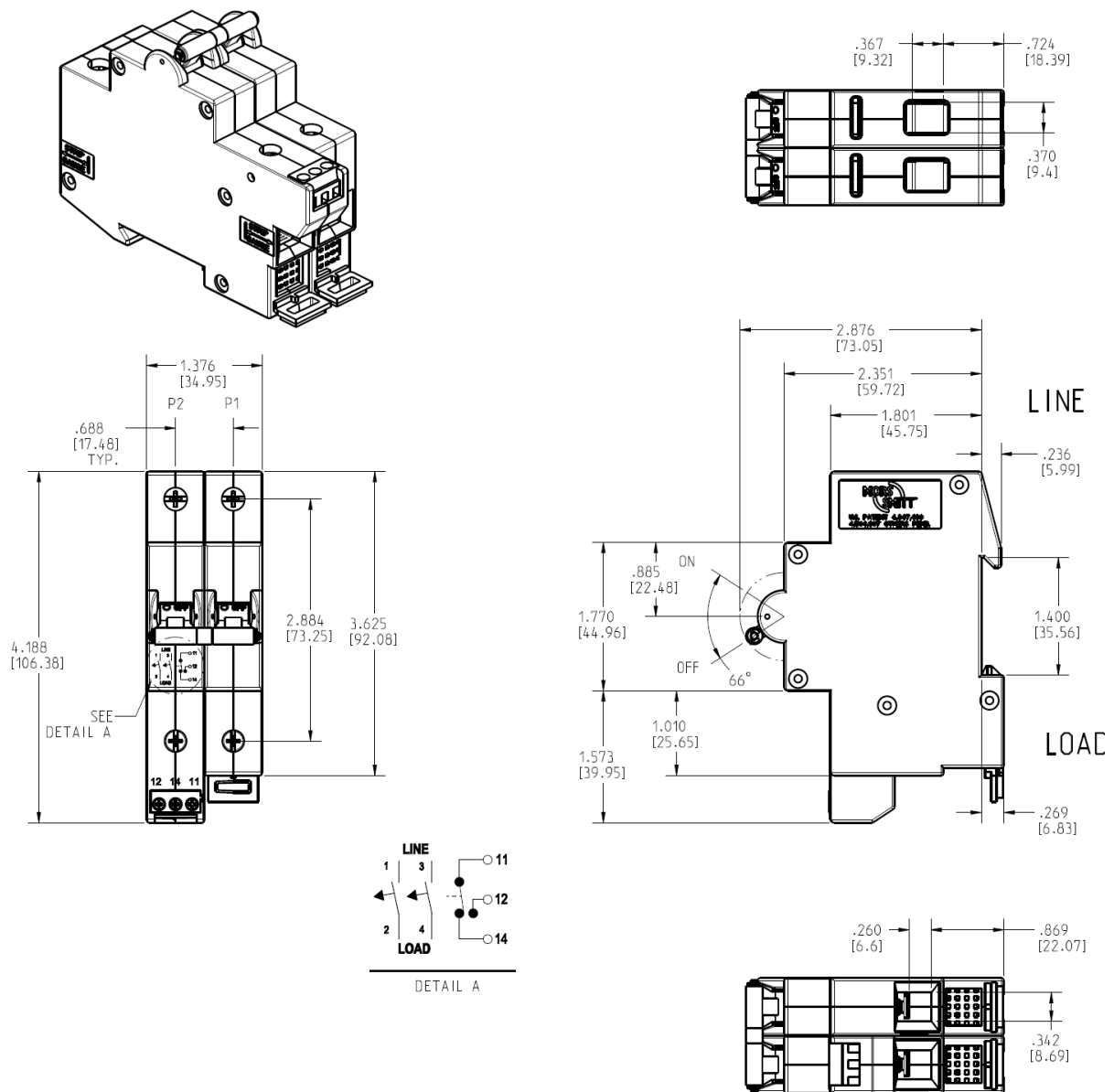

- Notes:
1. All dimensions are in inches [millimeters]
 2. Tolerance ± 0.01 [0.25] unless otherwise specified
 3. Angles $\pm 1^\circ$

Circuit breaker GR

Form & fit drawings

GR 2 poles with auxiliary switch (internal connector)

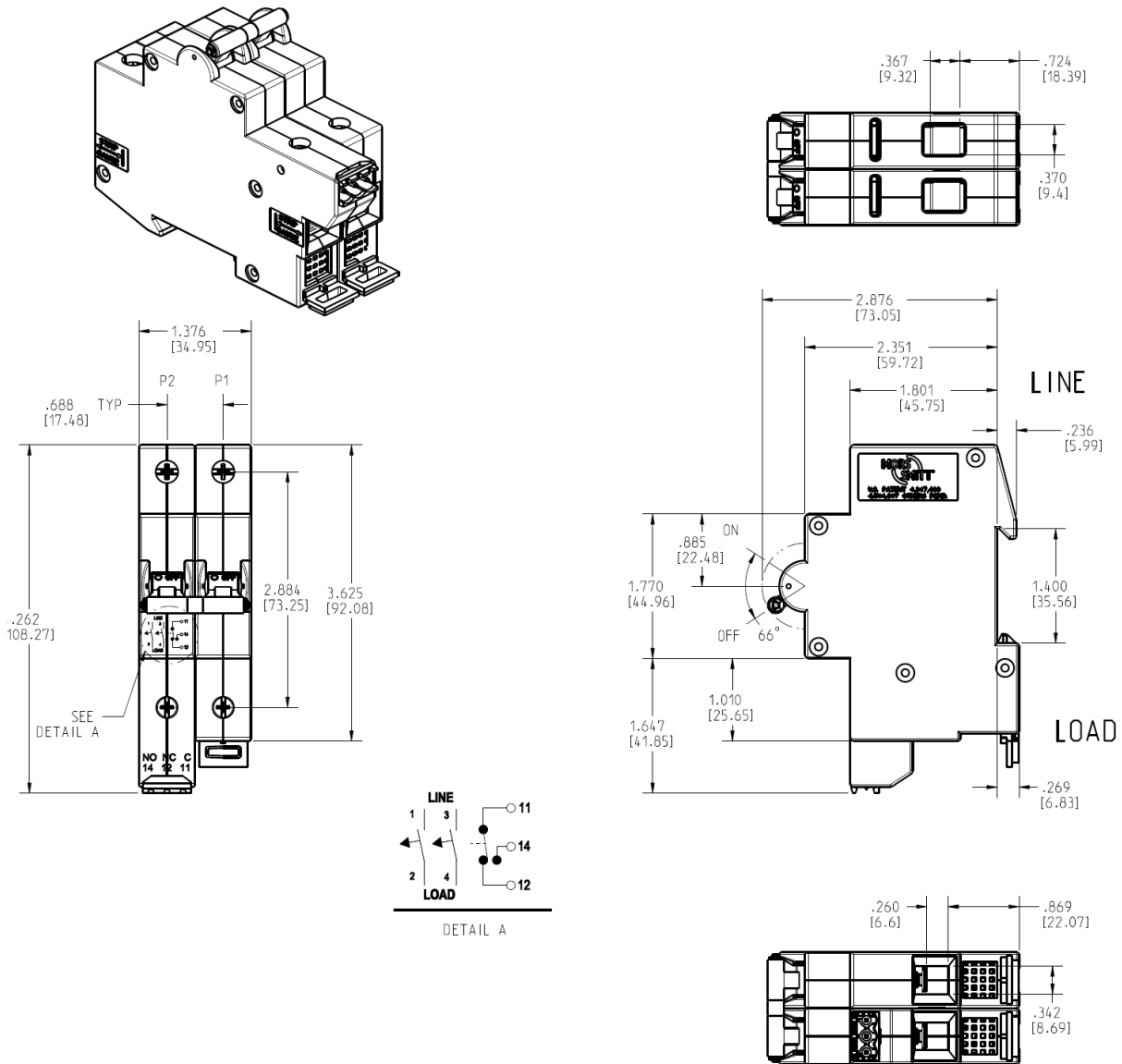

- Notes:
1. All dimensions are in inches [millimeters]
 2. Tolerance ± 0.01 [0.25] unless otherwise specified
 3. Angles $\pm 1^\circ$

Circuit breaker GR

Form & fit drawings

GR 3 poles with auxiliary switch (screw terminals)

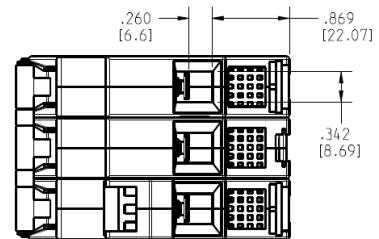
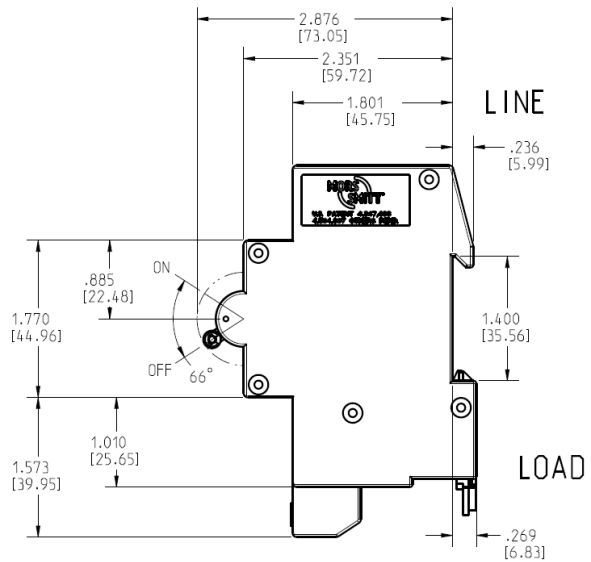
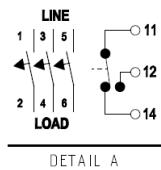
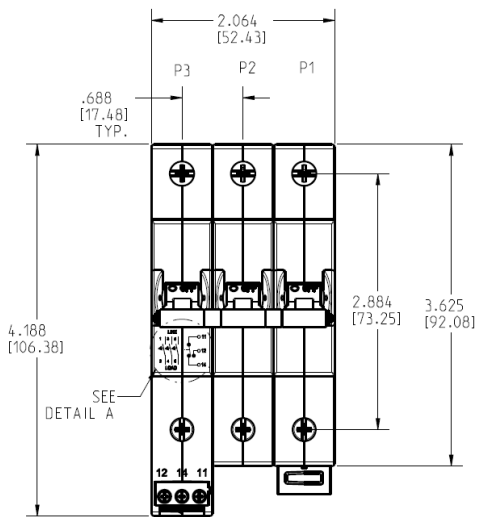
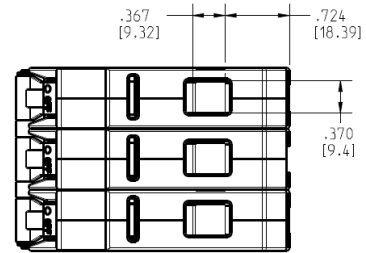
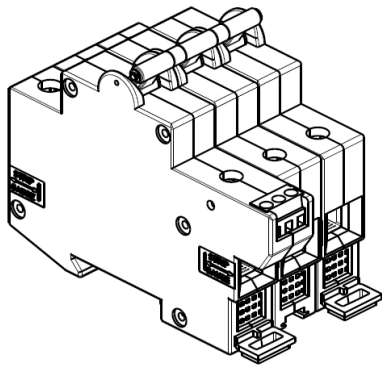

- Notes:
1. All dimensions are in inches [millimeters]
 2. Tolerance ± 0.01 [0.25] unless otherwise specified
 3. Angles $\pm 1^\circ$

Circuit breaker GR

Form & fit drawings

GR 3 poles with auxiliary switch (internal connector)

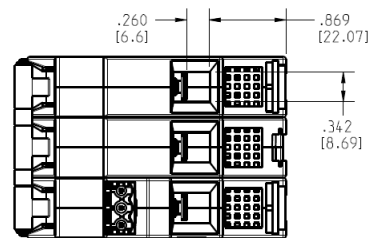
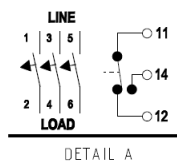
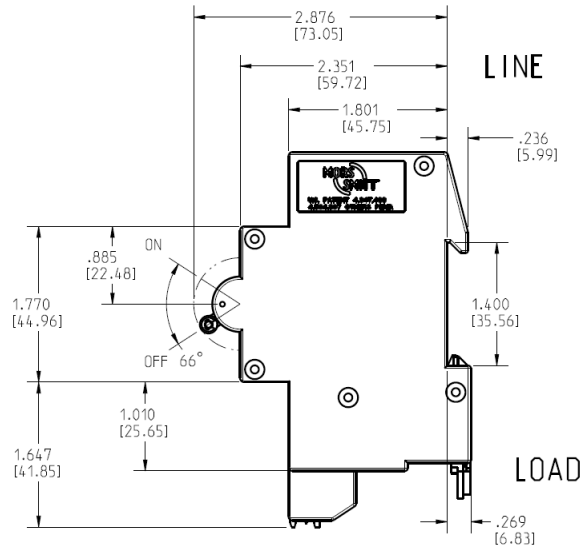
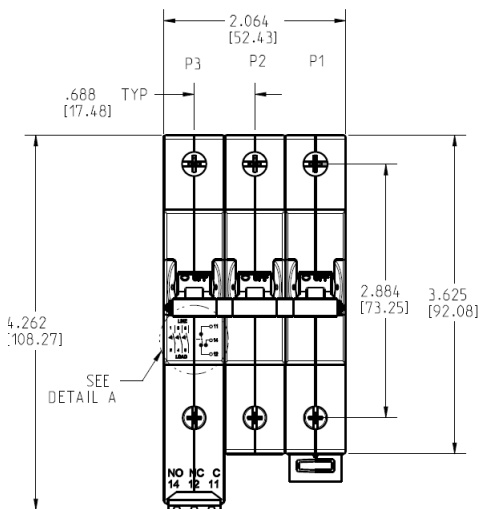
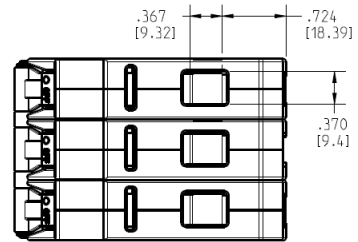
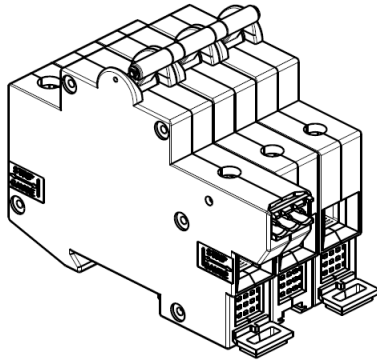

- Notes:
1. All dimensions are in inches [millimeters]
 2. Tolerance ± 0.01 [0.25] unless otherwise specified
 3. Angles $\pm 1^\circ$

Circuit breaker GR

Form & fit drawings

GR 4 poles with auxiliary switch (screw terminals)

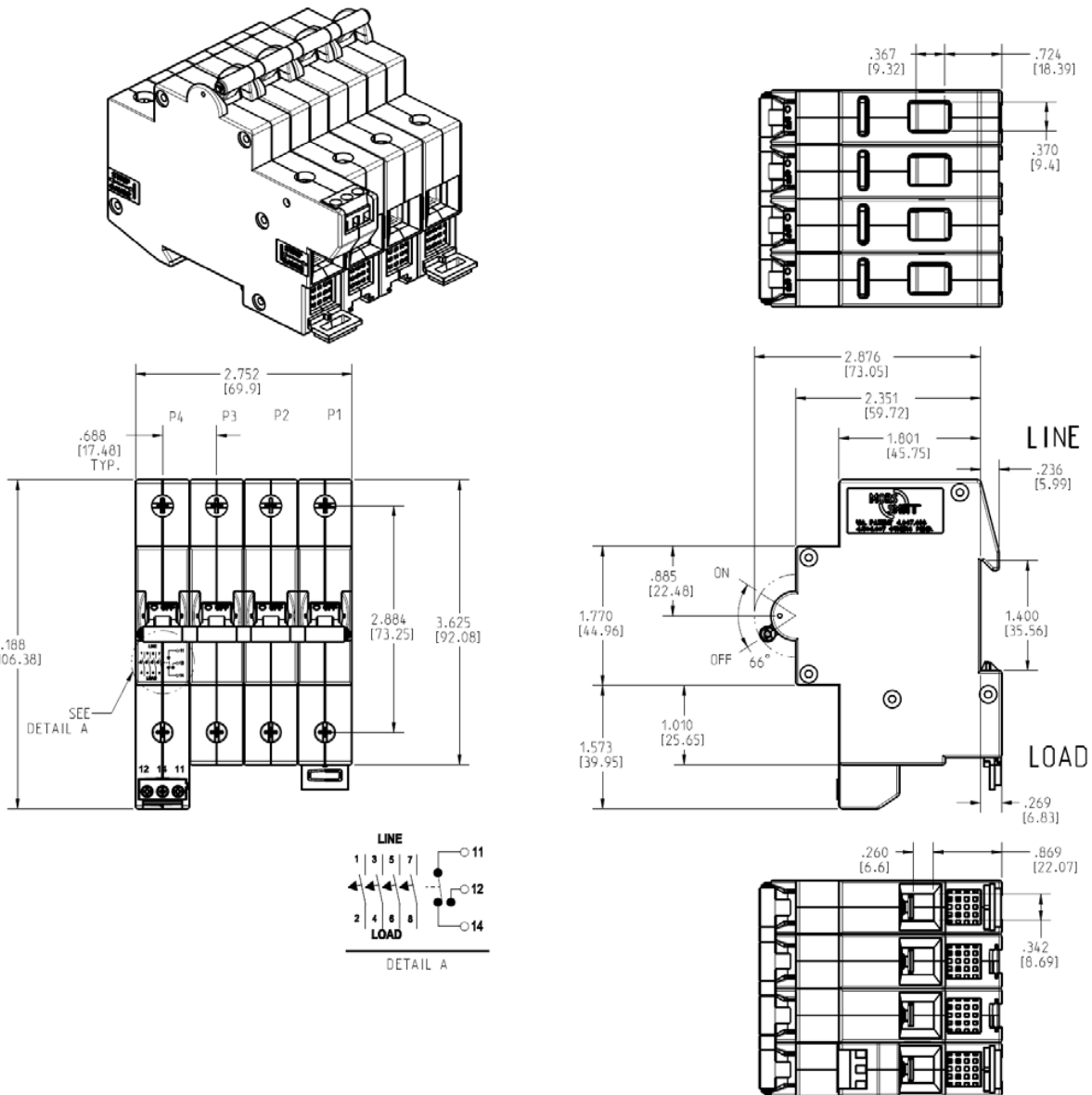

- Notes:
1. All dimensions are in inches [millimeters]
 2. Tolerance ± 0.01 [0.25] unless otherwise specified
 3. Angles $\pm 1^\circ$

Circuit breaker GR

Form & fit drawings

GR 4 poles with auxiliary switch (internal connector)

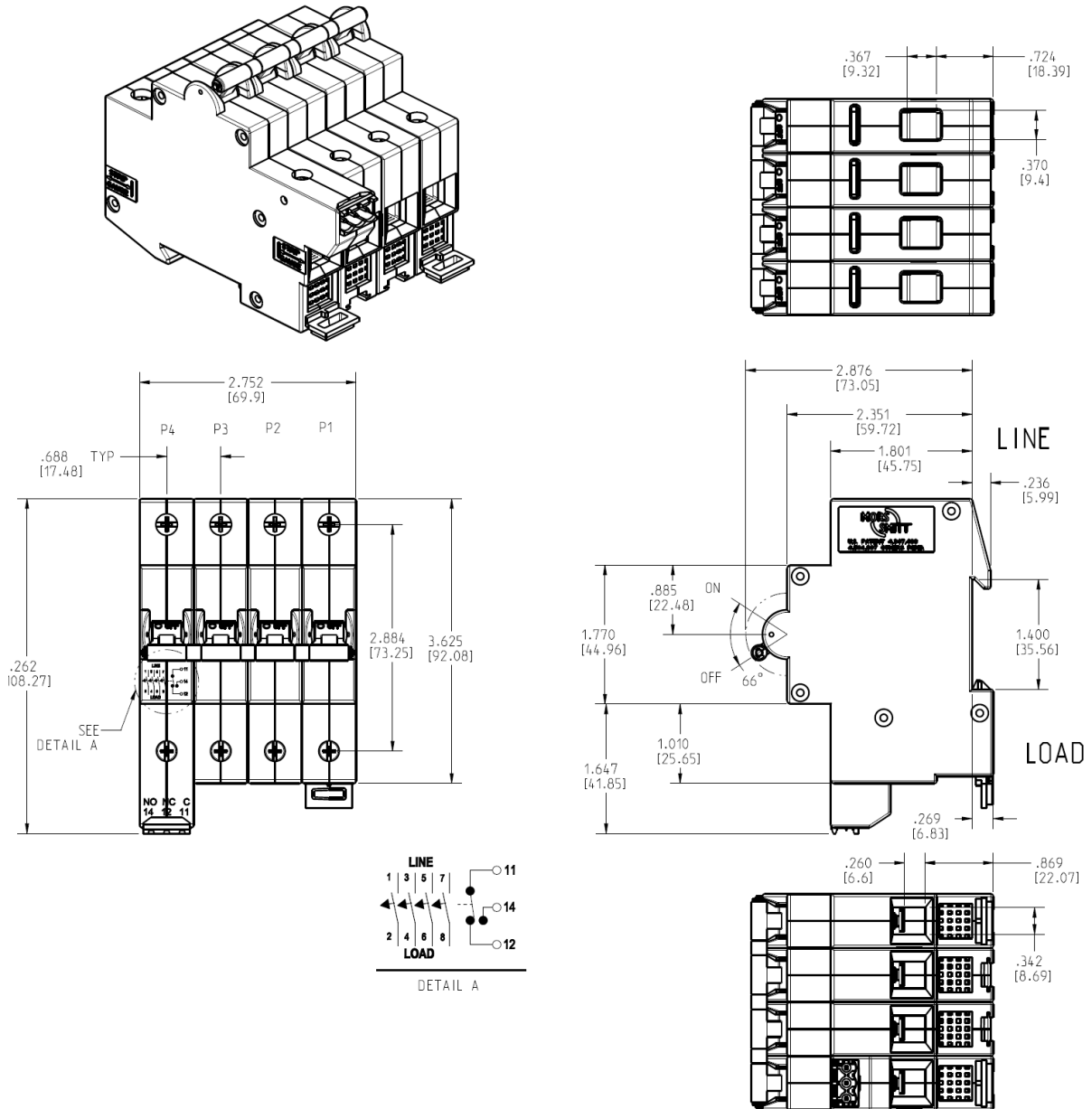

- Notes:
1. All dimensions are in inches [millimeters]
 2. Tolerance ± 0.01 [0.25] unless otherwise specified
 3. Angles $\pm 1^\circ$

Circuit breaker GR

Form & fit drawings

Busbar connection

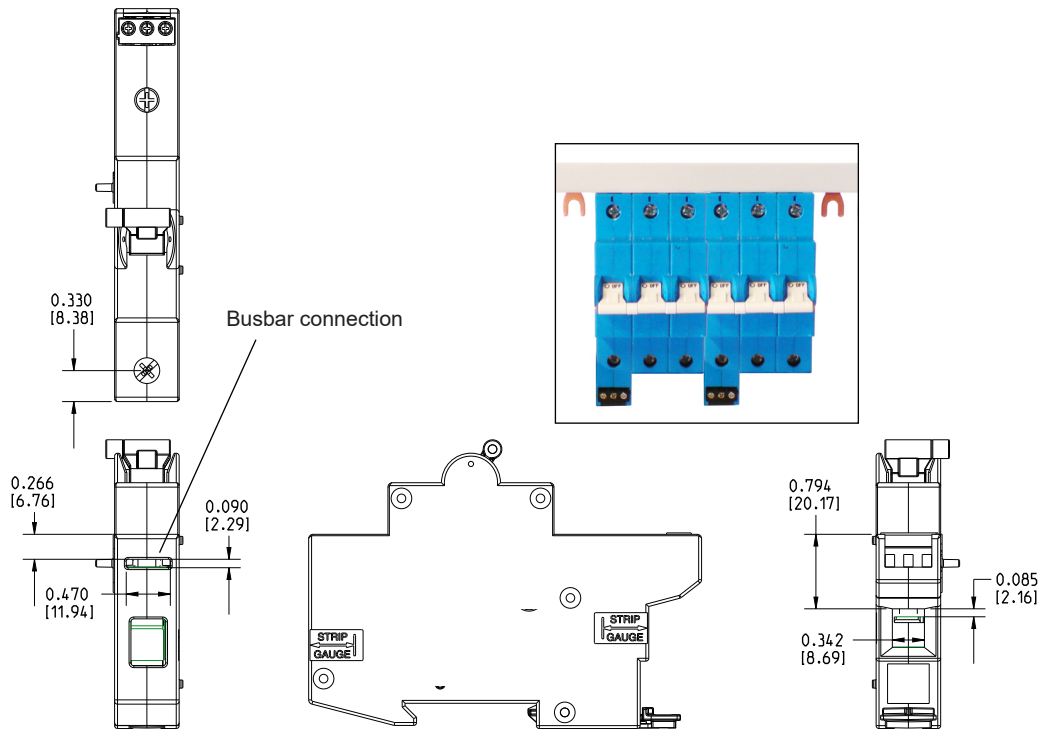

- Notes:
1. All dimensions are in inches [millimeters]
 2. Tolerance ± 0.01 [0.25] unless otherwise specified
 3. Angles $\pm 1^\circ$

Front panel clearance for circuitbreakers with an auxiliary switch (when panel is made of a conducting material)

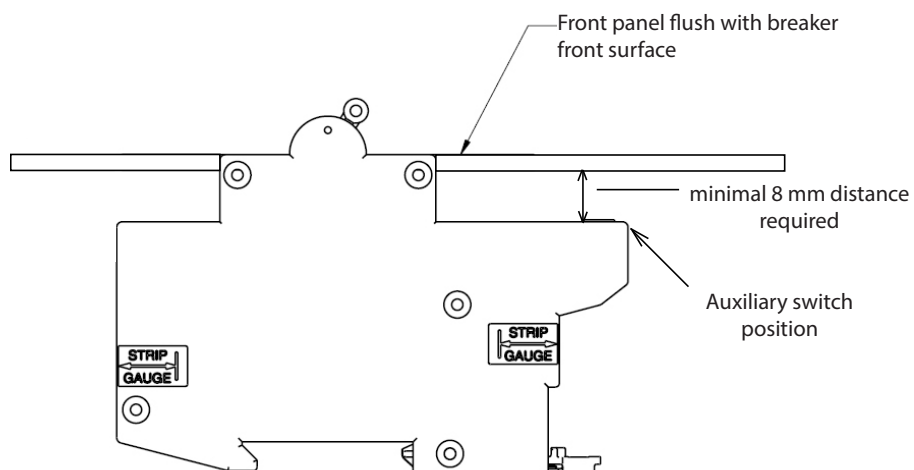

Circuit breaker GR

Circuit schematic

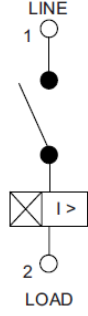
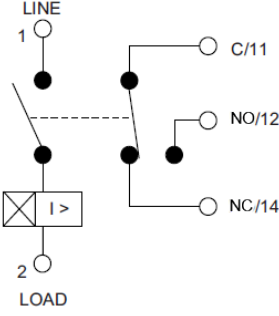
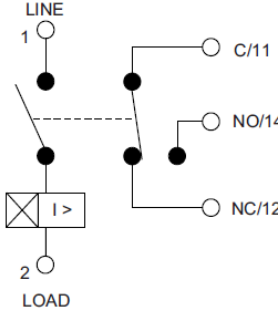
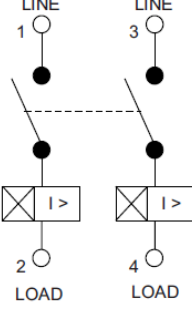
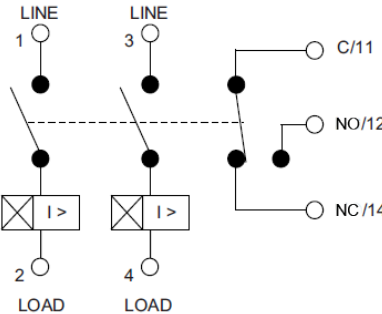
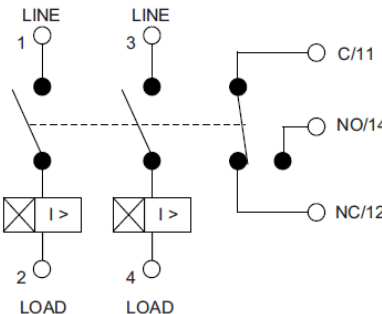
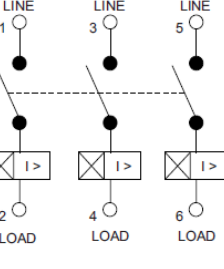
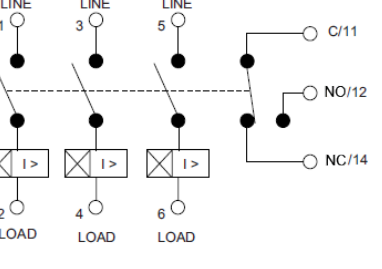
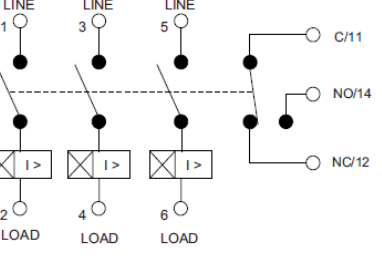
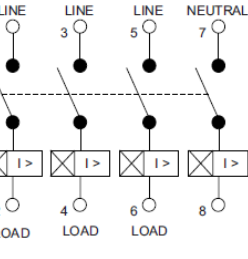
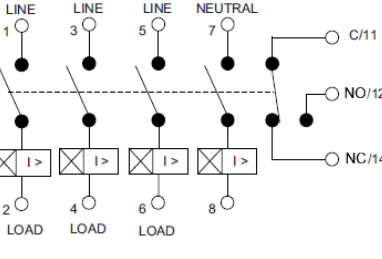
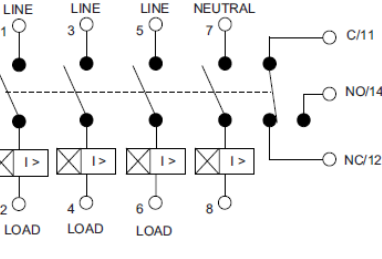
CIRCUIT SCHEMATIC		
<p>GR1</p> 	<p>WITH AUXILIARY SWITCH (SCREW TERMINALS)</p> 	<p>WITH AUXILIARY SWITCH (INTERNAL CONNECTOR)</p> 
<p>GR2</p> 	<p>WITH AUXILIARY SWITCH (SCREW TERMINALS)</p> 	<p>WITH AUXILIARY SWITCH (INTERNAL CONNECTOR)</p> 
<p>GR3</p> 	<p>WITH AUXILIARY SWITCH (SCREW TERMINALS)</p> 	<p>WITH AUXILIARY SWITCH (INTERNAL CONNECTOR)</p> 
<p>GR4</p> 	<p>WITH AUXILIARY SWITCH (SCREW TERMINALS)</p> 	<p>WITH AUXILIARY SWITCH (INTERNAL CONNECTOR)</p> 

Codes

At front of breaker the current rating and the delay type is shown with the following codes:

Half shell marking	Delay
SO	Switch only
DI	DC instantaneous
DU	DC ultra short
DS	DC short
DM	DC medium
DL	DC long
AI	50/60 Hz instantaneous
AUS	50/60 Hz ultra short
AS	50/60 Hz short
AM	50/60 Hz medium
AL	50/60 Hz long
ASH	50/60 Hz short, high inrush
AMH	50/60 Hz medium, high inrush
ALH	50/60 Hz long, high inrush
DSH	DC short, high inrush
DMH	DC medium, high inrush
DLH	DC long, high inrush

Circuit breaker

GR

Ordering scheme GR - page 1

GR	code continues on following page.....	
Poles	1		1 pole
	2		2 poles
	3		3 poles
	4		4 poles
Current rating (amperes) ¹	220		0.200
	250		0.500
	410		1.000
	415		4.500
	420		2.000
	425		2.500
	430		3.000
	435		3.500
	440		4.000
	445		4.500
	450		5.000
	460		6.000
	470		7.000
	480		8.000
	490		9.000
	610		10.000
	611		11.000
	612		12.000
	613		13.000
	615		15.000
	616		16.000
	617		17.000
	618		18.000
	620		20.000
	625		25.000
	630		30.000
	632		32.000
	635		35.000
	640		40.000
	650		50.000
	660		60.000
(Other ratings on request)	663		63.000
Frequency & delay	03		DC, 50/60 Hz, switch only
	10		DC instantaneous
	11		DC ultra short
	12		DC short
	14		DC medium
	16		DC long
	20		50/60 Hz instantaneous
	21		50/60 Hz ultra short
	22		50/60 Hz short
	24		50/60 Hz medium
	26		50/60 Hz long
	42		50/60 Hz short, hi-inrush
	44		50/60 Hz medium, hi-inrush
	46		50/60 Hz long, hi-inrush
	52		DC, short, hi-inrush
	54		DC, medium, hi-inrush
	56		DC, long, hi-inrush

Circuit breaker GR

Ordering scheme GR - page 2

.....
Circuit	A B							
Actuator		A S						
Actuator colour & legend			..					
Auxiliary switch			0 1 2 3 4 5 6 7 8					
Terminal				1				
Application rating					2 D 3			
Terminal polarity						A		
Agency approval ⁶							2 A	

Switch only (no coil) ²															
Series trip (current)															
Handle, one per pole															
Mid-trip handle, one per pole															
<table border="1"> <thead> <tr> <th>Actuator colour</th> <th>I-O</th> <th>On-Off</th> <th>Dual</th> <th>Legend colour</th> </tr> </thead> <tbody> <tr> <td>White</td> <td>A</td> <td>B</td> <td>1</td> <td>Black</td> </tr> <tr> <td>Black</td> <td>C</td> <td>D</td> <td>2</td> <td>White</td> </tr> </tbody> </table>	Actuator colour	I-O	On-Off	Dual	Legend colour	White	A	B	1	Black	Black	C	D	2	White
Actuator colour	I-O	On-Off	Dual	Legend colour											
White	A	B	1	Black											
Black	C	D	2	White											
Without auxiliary switch															
S.P.D.T. screw terminal															
S.P.D.T. screw terminal, gold contacts															
S.P.D.T. screw terminal with internal diode															
S.P.D.T. screw terminal, gold contacts, with internal diode															
Internal connector															
Internal connector, gold contacts															
Internal connector with internal diode															
Internal connector, gold contacts, with internal diode															
Screw terminal															
110 VDC															
240 VAC															
440VAC ⁴															
Non-polarity sensitive ⁵															
For single pole DC breaker:															
1 Load terminal (+connected with bottom terminal)															
2 Line terminal (+connected with top terminal)															
2 TUV certified															
A No agency approvals (configuration not tested by external agency)															

Special configurations, not covered by this ordering scheme, on request.

Example : GR1-610-24-B-A1-2-1-DA-2

Notes:

- When a breaker is mounted with the handle pointing downwards (e.g. ceiling mounting) the nominal value of the breaker will decrease with 10%. In this situation it is recommended to add 10 % to the rated current
- Current rating in switch only circuit:
 - for 0.2 to 30 A select current code 630
 - for 30 to 50 A select current code 650
 - for 50 to 63 A select current code 663
- On multi-pole breakers one auxiliary switch is supplied, mounted in the extreme left pole (front view)
- 3 pole breaker required
- Requires AC rating or multi-pole DC break (contacts in series)
- TUV certified: only for actuator legend 'Dual' and 'I-O'
 Not for actuator legend 'ON-OFF', not for switch only circuit, not for DC more than 2 poles, not for delay curve 56; use code A instead (no agency approvals)

Circuit breaker
GR

 **Over 10 million Mors Smitt relays in use in rail transport applications worldwide!**

Mors Smitt Asia Ltd.
Unit B & C, 25/F., Casey Aberdeen House
38 Heung Yip Road, Wong Chuk Hang
Hong Kong
Tel: +852 2343 555
sales.msa@wabtec.com

Mors Smitt France SAS
2 Rue de la Mandinière
72300 Sablé-sur-Sarthe, France
Tel: +33 (0) 243 92 82 00
sales.msfr@wabtec.com

Mors Smitt UK Ltd.
Graycar Business Park
Burton on Trent, DE13 8EN, UK
Tel: +44 (0)1283 357 263
sales.msuk@wabtec.com

Wabtec Netherlands B.V.
Darwinstraat 10
6718 XR Ede, Netherlands
Tel: +31 (0)88 600 4500
sales.msbv@wabtec.com

Mors Smitt Technologies Ltd.
1010 Johnson Drive
Buffalo Grove, IL 60089-6918, USA
Tel: +1 847 777 6497
salesmst@wabtec.com

RMS Mors Smitt
19 Southern Court
Keysborough, VIC 3173, Australia
Tel: +61 (0)3 8544 1200
sales.rms@wabtec.com

(c) Copyright 2021

All rights reserved. Nothing from this edition may be multiplied, or made public in any form or manner, either electronically, mechanically, by photocopying, recording, or in any manner, without prior written consent from Mors Smitt. This also applies to accompanying drawings and diagrams. Due to a policy of continuous development Mors Smitt reserves the right to alter the equipment specification and description outlined in this datasheet without prior notice and no part of this publication shall be deemed to be part of any contract for the equipment unless specifically referred to as an inclusion within such contract. Mors Smitt does not warrant that any of the information contained herein is complete, accurate, free from potential errors, or fit for any particular purpose. Mors Smitt does not accept any responsibility arising from any party's use of the information in this document.