

/// Plug-in railway relay with 4 C/O contacts

Rugged plug-in relays for extreme reliability, within long endurance applications and harsh environments

FDC4-U200

Flashing relay

Part of D-platform



Features

- Flashing relay (asymmetrical)
- Compact plug-in design
- 4 C/O contacts
- Pulse time adjustable with a lockable knob
- Also available with fixed pulse time
- Pulse time and cycle time between 0 s...60 min
- Magnetic arc blow-out
- Two LEDs for status indication
- Flat, square and silver plated relay pins for excellent socket connection
- Wide range sockets
- Integrated snap-lock
- Transparent cover
- Optional positive mechanical keying relay to socket

Description

Plug-in electronic railway flashing timer relay with four change-over contacts. When the relay is activated the coil is energized with a pulse. The pulse time is adjustable with a lockable knob. The relay can also be supplied with a fixed pulse time (no knob).

The relay is equipped with two LEDs which indicate the presence of power supply and the energizing of the coil. Also standard equipped with magnetic arc blow-out for high breaking capacity and long contact life.

The construction of the relay and choice of materials makes the FDC4-U200 relay suitable to withstand low and high temperatures, shock & vibration and dry to humid environments.

No external retaining clip needed as integrated 'snap-lock' will hold relay into socket under all circumstances and mounting directions.

Compact design, choice of many options and a wide range of sockets makes the FDC4-U200 relay an easy and flexible solution to use.

Application

These relay series are designed for demanding rolling stock applications. The FDC4-U200 is used in applications where an asymmetrical pulse frequency in output is necessary after activating the relay.

Connection diagram

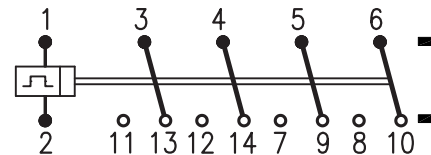

Timing diagram

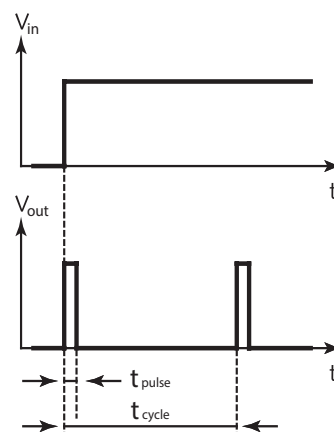

Railway compliancy

| | |
|-----------|----------------|
| EN 50155 | EN 50121 |
| IEC 60571 | EN 45545-2 |
| IEC 60077 | NF F16-101/102 |
| IEC 60947 | NF F 62-002 |
| IEC 61373 | |

Flashing relay FDC4-U200

Options

- Low temperature (-40 °C), max. contact current 8 A
- Gold plated contacts
- Extra dust protection
- AgSnO₂ contacts, high resistant to welding
- No magnetic arc blow-out
- Double zener diode over coil
- Double make/double break contacts
- Keying

Remark: Not all combinations possible

Dimensions (mm)

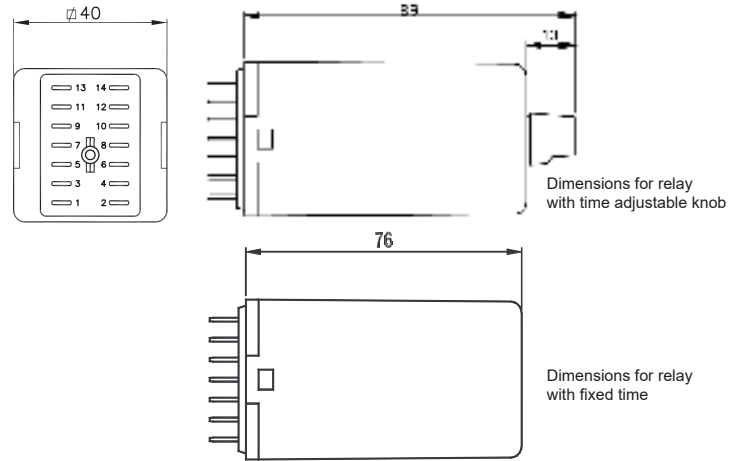

Sockets

| | | Mounting | | | |
|---------------------|------------------------|----------------|------------|---------------|-----|
| | | Surface / Wall | 35 mm rail | Panel / Flush | PCB |
| Terminal connection | Screw | V23 | V23 | - | - |
| | Screw - wide terminals | V22 BR | V23 BR | - | - |
| | Spring clamp | V29 | V29 | V33 | - |
| | Faston | - | - | V31 | - |
| | Crimp | - | - | V26 | - |
| | Solder tag | - | - | V3 | - |
| | PCB | - | - | - | V32 |

For more information see the respective datasheets

Flashing relay FDC4-U200

Technical specifications

Pulse characteristics

| | | |
|---|-----------------------|--|
| Pulse function | | Flashing (asymmetrical) |
| Time | Fixed cycle | Factory set between 0 s...60 min |
| | Adjustable pulse | Adjustable between 0 s ...cycle time |
| | Fixed pulse | Factory set between 0 s ...cycle time |
| Accuracy | Set value in factory | < 2.5 % |
| | Adjustment | < 10 % of full schale. After adjusting / fixed time setting; no variation in setpoint |
| | Voltage variation | ± 0.05 % / % Unom |
| | Repeatability | ± 0.5 % |
| | Temperature variation | ± 0.02 % / K |
| Recovery time | | ± 0.1 s |
| Release time | | < 30 ms |
| Maximum permissible ripple | | 50 % |
| Example Cycle time: 5 s Adjustable pulse time set on 2 s : it will be between 1.5 s...2.5 s. For example: 2.0 s. The ambient temperature is 40° C. which is 20 degrees different compared to the standard 20° C. This results in 0.4 % pulse time variation. The applied voltage is 30 % lower than the nominal voltage. This results in 1.5 % extra pulse time variation. The total pulse time variation is then 0.5 % (repeatability) + 0.4 % (due to temperature) + 1.5 % (due to voltage) = 2.4 %. In this case the pulse time will be between 1.95 s and 2.05 s. | | |

Coil characteristics

| | | |
|---------------------------|-------------------|---|
| Operating voltage range | | 0.7...1.25 Unom |
| Nominal power consumption | During time delay | < 0.875 W (220 V) < 0.375 W (110 V) Lower voltage = lower power |
| | After time delay | < 3.6 W (220 V) < 3 W (110 V) Lower voltage = lower power |

| Type | Unom (VDC) | Umin (VDC) | Umax (VDC) | Udrop-out (VDC) |
|--------------|------------|------------|------------|-----------------|
| FDC4-U201-xx | 24 | 16.8 | 30 | 2.4 |
| FDC4-U202-xx | 48 | 33.6 | 60 | 4.8 |
| FDC4-U203-xx | 72 | 50.4 | 90 | 7.2 |
| FDC4-U204-xx | 110 | 77.0 | 138 | 11.0 |
| FDC4-U205-xx | 96 | 67.2 | 120 | 9.6 |
| FDC4-U207-xx | 36 | 25.2 | 45 | 3.6 |

Other types on request

Remarks:

- Umin is the must-operate voltage at which the relay has picked up in all circumstances (worst-case situation), in practice the relay picks up at a lower voltage
- Udrop-out is the must-release voltage at which the relay has dropped-out in all circumstances (worst-case situation), in practice the relay drops out at a higher voltage (Urelease)
- To reset the time function, the voltage must drop below Udrop-out
- Always select the nominal voltage as close as possible to the actual voltage in the application

Flashing relay FDC4-U200

Contact characteristics

| | | |
|--|-------------|---|
| Amount and type of contacts | | 4 C/O |
| Maximum make current | | 16 A |
| Peak inrush current | NF F 62-002 | 200 A (withstand > 10 x 200 A @ 10 ms, 1 min) |
| Maximum continuous current | | 10 A |
| Maximum switching voltage | | 250 VDC, 440 VAC |
| Minimum switching voltage | | 12 V |
| Minimum switching current | | 10 mA |
| Maximum breaking capacity (> 50.000 operations) | | 72 VDC, 5 A (L/R ≤ 40 ms) 110 VDC, 10 A (resistive load) 110 VDC, 0.5 A (L/R ≤ 40 ms) |
| Contact resistance | | 15 mΩ (initial) |
| Material | | Ag standard (optional AgSnO ₂ , Au on Ag) |
| Contact gap | | 0.7 mm |
| Contact force | | > 200 mN |

Electrical characteristics

| | | |
|---------------------|---------------|----------------------|
| Dielectric strength | Pole-pole | 4 kV, 50 Hz, 1 min |
| | Cont-coil | 2.kV, 50 Hz, 1 min |
| | Open contacts | 2.5 kV; 50 Hz; 1 min |
| EMC | EN 50121-3-2 | |

Mechanical characteristics

| | | |
|-----------------------------|--|--|
| Mechanical life | | 30 x 10 ⁶ operations |
| Maximum switching frequency | | Mechanical: 3600 ops/h Electrical: 1200 ops/h |
| Torque value to lock knob | | 0.2-0.4 Nm |
| Weight | | 190 g (without options) |

Environmental characteristics

| | | |
|-----------------------|--|--|
| Environmental | | EN 50125-1 |
| Vibration | | IEC 61373, Category I, Class B, Body mounted |
| Shock | | IEC 61373, Category I, Class B, Body mounted |
| Operating temperature | | -25 °C...+70 °C (optional: -40 °C) |
| Humidity | | 95% (condensation is permitted temporarily) |
| Maximum altitude | | 2000 meter. Higher altitudes are possible but have consequences mentioned in IEC 60664 (for example 5000 meter with bigger clearance distance) |
| Salt mist | | IEC 60068-2-11, class ST4 |
| Damp heat | | IEC 60068-2-30, Test method Db variant 1 |
| Protection | | IEC 60529, IP40 (relay on socket) (with option K: IP50) |
| Fire & smoke | | NF F 16-101, NF F 16-102, EN 45545-2: HL3 for requirements R22, R23, R26 |
| Insulation materials | | Cover: polycarbonate Base: polyester |

Flashing relay FDC4-U200

Railway compliancy

| | |
|----------------|--|
| EN 50155 | Railway applications - Rolling stock - Electronic equipment |
| IEC 60571 | Railway applications - Electronic equipment used on rolling stock |
| IEC 60077 | Railway applications - Electric equipment for rolling stock |
| IEC 60947 | Low-voltage switchgear and controlgear |
| IEC 61373 | Railway applications - Rolling stock equipment - Shock and vibration tests |
| EN 50121 | Railway applications - Electromagnetic compatibility |
| NF F16-101/102 | Railway rolling stock - Fire behavior |
| EN 45545-2 | Railway applications - Fire protection on railway vehicles Part 2: Requirements for fire behavior of materials and components |
| NF F 62-002 | Railway rolling stock - On-off contact relays and fixed connections |

Options

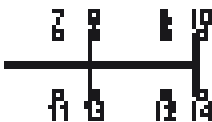
| Code | Description | Remark | Cannot be combined with: |
|-------------------|--|---|--------------------------|
| Standard options: | | | |
| C | Low temperature (-40 °C) | Icontact < 8 A | |
| E* | Au; Gold plated contacts | Yellow tape around relay for identification | M |
| K | Extra dust protection | IP50 Cat 2 for the relays mounted in a Mors Smitt socket. Application PD1/PD2 and contact load > 0.5 A. | |
| N | No magnetic arc blow-out | | |
| Q | Double zener diode over coil | Max. allowed peak voltage 180 V, higher voltage will damage the diode | |
| Y | Double make/double break contacts | 2 C/O DM/DB, -40 °C  | |
| Keying | Coil coding relay and socket | | |
| Special options: | | | |
| M | AgSnO ₂ ; "non-weldable" contacts | Icontact > 100 mA | E |

* Gold plated contacts characteristics

| | |
|---------------------------|---|
| Material | Ag, gold plated |
| Maximum switching voltage | 60 V (higher voltages may be possible, contact Mors Smitt for more information) |
| Maximum switching current | 400 mA (at higher rate gold will evaporate, then the standard silver contact rating of minimum 10 mA and 12 V is valid) |
| Minimum switching voltage | 5 V |
| Minimum switching current | 1 mA |

Remark: For application support or technical product support, contact your local Mors Smitt sales office (see contact details on last page).

Flashing relay FDC4-U200

Electrical life expectancy

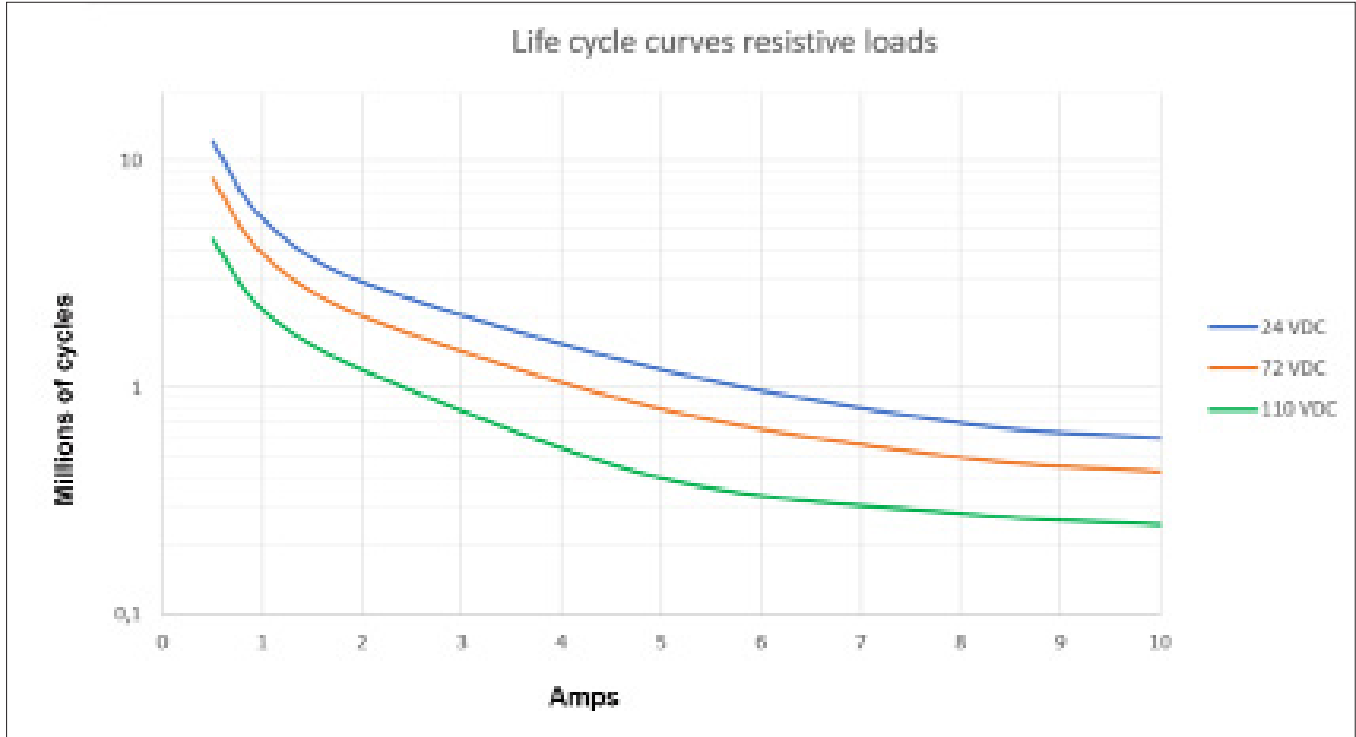

By connecting 2 contacts in series the DC current breaking capacity is increased by 50 %. Electrical lifetime is tested under laboratory conditions with switching frequency 0.33 Hz.

Note: The actual electrical lifetime in the application is affected by the switching frequency, type of contact (N/O or N/C), environmental conditions, etc.

Expected electrical lifetime inductive loads:

| Inductance | Voltage | % of resistive load | Remark |
|------------|---------|---------------------|--------------------|
| 15 ms | 24 VDC | 30 % | |
| 15 ms | 72 VDC | 25 % | Tested up to 8 A |
| 15 ms | 110 VDC | 20 % | Tested up to 0.5 A |
| 40 ms | 24 VDC | 10 % | |
| 40 ms | 72 VDC | 4 % | Tested up to 5 A |
| 40 ms | 110 VDC | 2 % | Tested up to 0.5 A |

For other contact loads: contact Mors Smitt.

Flashing relay FDC4-U200

Mounting possibilities/sockets



Surface/wall mounting

| | | |
|-----------|-------|---|
| 338000302 | V22BR | Screw socket, wall mount, front connection (9 mm terminals) |
| 338000580 | V23 | Screw socket, wall mount, front connection (7.5 mm terminals) |
| 338000610 | V29 | Spring clamp socket, wall mount, front dual connection (2.5 mm ²) |

Rail mounting

| | | |
|-----------|-------|---|
| 338000580 | V23 | Screw socket, rail mount, front connection (7.5 mm terminals) |
| 338000402 | V23BR | Screw socket, rail mount, front connection (9 mm terminals) |
| 338000610 | V29 | Spring clamp socket, rail mount, front dual connection (2.5 mm ²) |

Panel/flush mounting

| | | |
|-----------|-----|---|
| 338100100 | V3 | Solder tag socket, panel mount, rear connection |
| 328400100 | V26 | Crimp contact socket, panel mount, rear connection, A260 crimp contact |
| 338000560 | V31 | Faston connection socket, rear dual connection (4.8 x 0.8 mm) |
| 338000670 | V33 | Push-in terminal socket, panel mount, rear dual connection (3.3 mm ²) |

PCB mounting

| | | |
|-----------|-----|----------------------|
| 338000561 | V32 | PCB soldering socket |
|-----------|-----|----------------------|

No external retaining clip needed as the 'snap-lock' will hold the relay into the socket under all circumstances and mounting directions (according shock & vibration requirements IEC 61373, Category I, Class B, Body mounted). If regulations require external retaining clips, these are available as well.

For more details see datasheets of the sockets on www.morssmitt.com

Flashing relay FDC4-U200

Mechanical keying relay and socket (optional)

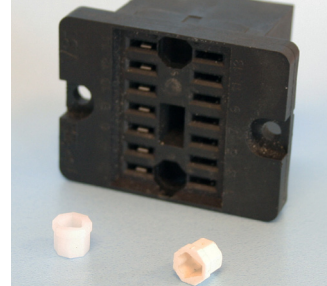
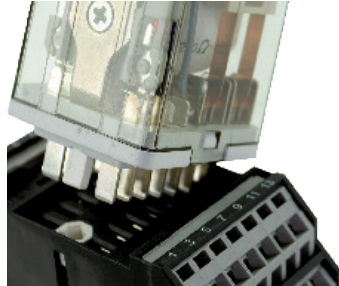

Function:

- To prevent wrong installation
- To prevent damage to equipment
- To prevent unsafe situations

Using keyed relays and sockets prevents a relay is inserted in a wrong socket. For example it prevents that a 24 VDC relay is put in a 110 VDC circuit. Positive discrimination is possible per different function, coil voltage, timing, monitoring, safety and non-safety.

The D relay socket keying option gives $8 \times 8 = 64$ possibilities. Upon ordering the customer simply indicates the need for the optional keying. Mors Smitt will assign a code to the relay and fix the pins into the relay. The sockets are supplied with loose key receptacles. Inserting the keys into the socket is very simple and self explaining.

Remark: Sockets and relay shown are examples.

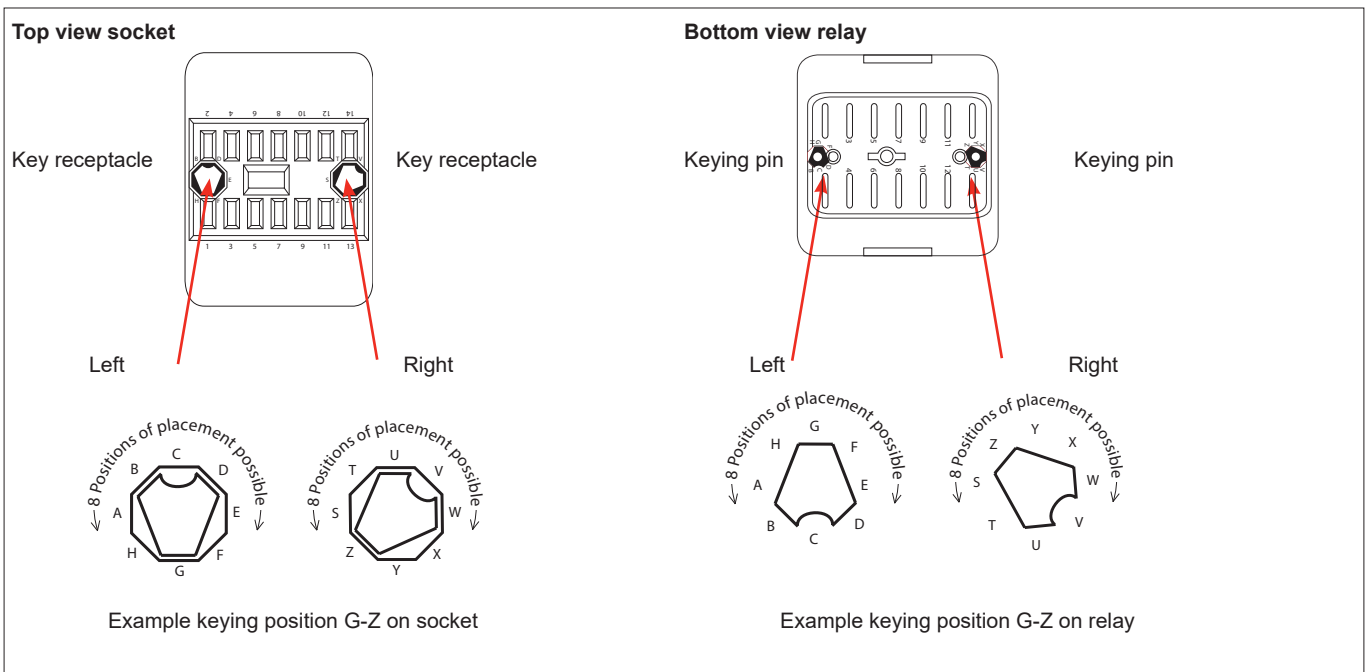

Flashing relay FDC4-U200

Important for relay selection and operation

Make sure the relay is suitable for the application. For critical applications (for example: green loop applications) relays should be checked on correct working during periodic inspection.

Recommendations for long time contact reliability

For relays to enable failure free performance over a very long operational time, it is important to create the right circumstances. In any relay, contact usage and atmospheric conditions influence the contact surface. To counter this effect it is common practice to use a safety factor of > 2 to ensure long time contact reliability.

Therefore for long time contact reliability we recommend:

- Silver contacts: a minimum contact current of 20 mA per contact
- Gold contacts: a minimum contact current of 10 mA per contact
- Double Make Double Break contacts: a minimum contact current of 40 mA per contact
- When low currents are switched and not frequently, e.g. 10 mA once a day, it is advised next to gold plated contacts to put similar contacts within the same relay in parallel
- With higher load switching, e.g. 110 VDC and > 1 A, put relay contacts in series
- Rule of thumb: any relay works best with switching currents > 20 mA in DC environment when frequently switched. When not switched frequently a higher switching current like 50 mA is better for a long reliable operational time
- Check relays regularly, for example with the Mors Smitt Portable Relay Tester and visually through the transparent cover

Instructions for use

Installation

Before installation or working on the relay: disconnect the power supply first (no hot swapping)! Install socket and connect wiring according to the terminal identification. Plug relay into the socket ensuring there is no gap between the bottom of relay and the socket. Reverse installation into the socket is not possible due to the mechanical blocking snap-lock feature. Check to ensure that the coil connection polarity is not reversed. Relays can be mounted tightly together to save space. When rail mounting is used, always mount the socket in the direction of the UP arrow, to have proper fixation of the socket on the rail. Torque value screw to lock knob: 0.2-0.4 Nm.

Warning!

- Never use silicon in the proximity of the relays
- Do not use the relay in the presense of flammable gas as the arc generated from switching could cause ignition
- To remove relays from the socket, employ up and down lever movements. Sideway movement may cause damage to the coil wires

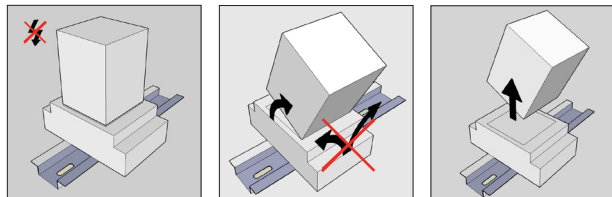

- Relays should never be swapped to other circuit positions when taken out of its socket for inspection or fault finding, always place it back into the original position to prevent contact resistance problems. Contact resistance problems can be created when swapping relays between different circuit loads due the contact wear/condition having changed during its operational life.

Operation

After installation always apply the rated voltage to the coil to check correct operation. Long term storage may corrode the silver on the relay pins. When plugging the relay into the socket, the female bifurcated or trifurcated receivers will automatically cut through the corrosion on the pins and guarantee a reliable connection.

Before actual use of relays, it is advised to switch the load several times with the contacts. The contacts will both be electrically and mechanically cleaned due to the positive wiping action. Sometimes a contact can build up increased contact resistance (≤ 15 m Ω when new). When using silver contacts one can clean the contact by switching a contact load a few times using >24 VDC & ~ 2 A. Increased contact resistance is not always problematic, as it depends on circuit conditions. In general a contact resistance of 1 Ω is no problem, consult Mors Smitt for more information.

Condensation in the relay is possible when the coil is energised (warm) and the outside, environmental temperature is cold. This is a normal phenomenon and will not affect the function of the relay. Materials in the relay have no hygroscopic properties.

Flashing relay FDC4-U200

Inspection / maintenance

Correct operation of the relay can easily be checked as the transparent cover provides good visibility of the moving contacts. If the relay does not seem to operate correctly, check for presence of the appropriate coil voltage and polarity using a suitable multimeter. If a LED is fitted, it indicates voltage presence to the coil. If coil voltage is present, but the relay does not operate, a short circuit of the suppression diode is possible (This may have been reversed due to the coil connection).

Relays can easily be tested with the Mors Smitt Relay Tester. More information on: www.morssmitt.com.

If the relay doesn't work after inspection, replace the relay unit with a similar model. Do not attempt to open the relay cover or try to repair. Contacts are calibrated and in balance, touching can affect proper operation. Also resoldering may affect correct operation. Since 2009 relays have tamper proof seals fitted and once broken, warranty is void.

Most relay defects are caused by installation faults such as overvoltage, spikes/transients, high/short current far exceeding the relay specifications. When returning the relays for investigation, please provide all information on the RMA form. Send defective relays back to the manufacturer for repair or replacement. Normal wear and tear or external causes are excluded from warranty.

RMA procedure see www.morssmitt.com

Flashing relay FDC4-U200

Ordering scheme

| FDC4-U | | - | | | |
|---|------------|---|--------------------|--|--------------------------|
| Coil voltages | 201 | | | 24 VDC | |
| | 207 | | | 36 VDC | |
| | 202 | | | 48 VDC | |
| | 203 | | | 72 VDC | |
| | 205 | | | 96 VDC | |
| | 204 | | | 110 VDC | |
| Options (add as many options as needed) | C | | | Low temperature (-40 °C) - Max contact current 8 A | |
| | E | | | Gold plated contacts | M |
| | K | | | Extra dust protection, IP50 | |
| | N | | | No magnetic arc blow-out | |
| | Q | | | Double zener diode | |
| Special options (minimum order quantity: 20) | Y | | | Double make/double break (-40 °C) | |
| | M | | | AgSnO ₂ contacts, highly resistant to welding | E |
| Pulse time | | | / | Fixed cycle time | between 0 s... 60 min |
| | | | | Fixed pulse time | between 0 s...cycle time |
| | | | | Adjustable pulse time | between 0 s...cycle time |

Examples:

FDC4-U204-CE 0-10 s/10 s

Description: FDC4-U204 relay, Unom 110 VDC, low temperature (-40 °C), gold plated contacts, pulse time: adjustable, cycle time 10 seconds

Flashing relay
FDC4-U200

 **Over 11 million Mors Smitt relays in use in rail transport applications worldwide!**

Mors Smitt Asia Ltd.
Unit B & C, 25/F., Casey Aberdeen House
38 Heung Yip Road, Wong Chuk Hang
Hong Kong
Tel: +852 2343 555
sales.msa@wabtec.com

Mors Smitt France SAS
2 Rue de la Mandinière
72300 Sablé-sur-Sarthe, France
Tel: +33 (0) 243 92 82 00
sales.msf@wabtec.com

Mors Smitt UK Ltd.
Graycar Business Park,
Burton on Trent, DE13 8EN, UK
Tel: +44 (0)1283 357 263
sales.msuk@wabtec.com

Wabtec Netherlands B.V.
Vrieslantlaan 6,
3526 AA, Utrecht, Netherlands
Tel: +31 (0)30 288 1311
sales.msbv@wabtec.com

Mors Smitt Technologies Ltd.
1010 Johnson Drive,
Buffalo Grove, IL 60089-6918, USA
Tel: +1 847 777 6497
salesmst@wabtec.com

RMS Mors Smitt
6 Anzed Court,
Mulgrave, VIC 3170, Australia
Tel: +61 (0)3 8544 1200
sales.rms@wabtec.com

(c) Copyright 2022

All rights reserved. Nothing from this edition may be multiplied, or made public in any form or manner, either electronically, mechanically, by photocopying, recording, or in any manner, without prior written consent from Mors Smitt. This also applies to accompanying drawings and diagrams. Due to a policy of continuous development Mors Smitt reserves the right to alter the equipment specification and description outlined in this datasheet without prior notice and no part of this publication shall be deemed to be part of any contract for the equipment unless specifically referred to as an inclusion within such contract. Mors Smitt does not warrant that any of the information contained herein is complete, accurate, free from potential errors, or fit for any particular purpose. Mors Smitt does not accept any responsibility arising from any party's use of the information in this document.