

PROTECTION OF AIR INSULATED METAL CLAD SWITCHGEAR

# Arc Fault Monitoring System 1S24

Arc fault protection to provide high speed detection and clearance of arcing faults.

- > 16 Point Arc Sensors
- > 12 Point + 2 Linear Arc Sensor Version
- > 3 High speed trip outputs
- > IEC61850 capable
- > Optic fibre or RJ45 communications
- > Suitable for simple or complex switchboards
- > Surface, DIN rail or flush mounting options
- > Made in Australia

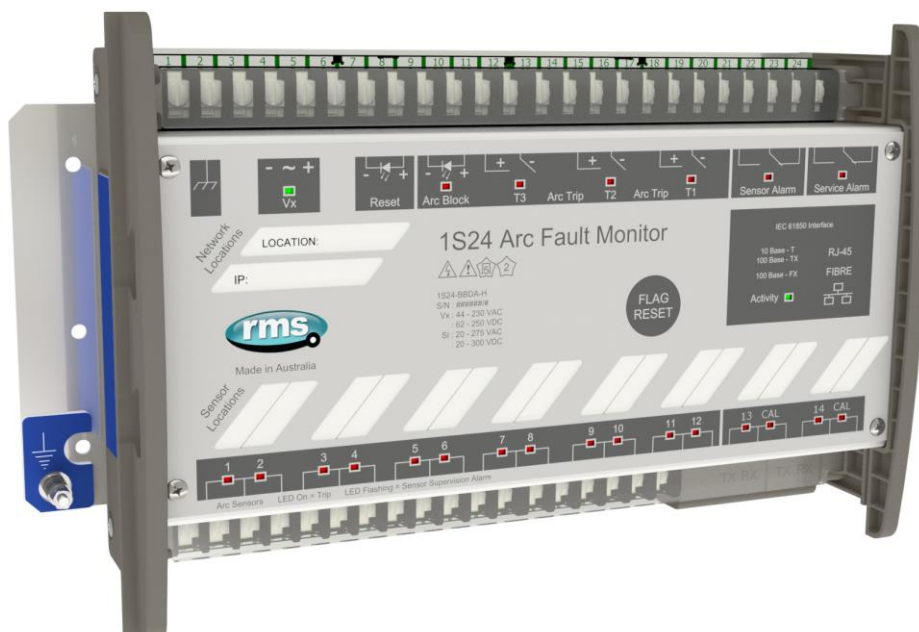

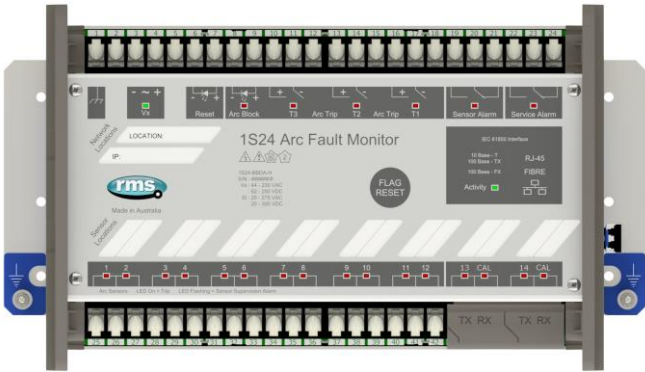

Figure 1: 1S24 Arc Fault Module

## Description

The 1S24 relay is designed to detect the high intensity light emitted by the onset of an electrical arcing event. The 1S24 may be employed to create a comprehensive arc fault protection system comprising the following components:

### Optical sensor

1S30 point sensors and 1S40 linear sensors are available to provide wide detection coverage within metal clad switchgear, cable compartments and bus bars.

### Arc Flash Monitor

The 1S24 provides an interface between the optical sensors and an IEC61850 station bus network. The 1S24 also takes care of sensor supervision and allows for direct tripping of circuit breakers for high speed clearance of arcing faults.

### IEC61850 Station Bus Network

An optical or electrical Ethernet network is employed to connect the 1S24 relays to other IED's in the protection system.

### Protection System IED's

Complex system operation may be developed and programmed using the logic functions available in the IEC61850 enable IED's to create a suitable arc flash protection scheme.

## Arc Fault Protection

Arc fault protection is a relatively new technique employed for the clearance of arcing faults on low voltage panels, MCC's, BUS bars and within metal clad switchgear and associated cable boxes.

Conventional current based protection techniques are at times challenged by the nature of arcing faults, and can result in slow protection clearance times. Slow protection clearance times increase the risk to nearby personnel and increase the degree of damage to plant and equipment.

By employing an optical detection technique, Arc Fault Protection results in fast clearance of arcing faults.

With the added benefit of IEC61850 Goose Messaging, the 1S24 is a scalable solution capable of being employed in the most challenging applications with reduced engineering overhead.

With the flexibility of the IEC 61850 standard ARC tripping with current checking or ARC tripping with operational interlocks can be implemented with ease.

## Features

- > Up to 16 arc fault sensors
- > 16 point or 12 point + 2 linear arc sensors
- > High speed arc fault tripping duty contacts
- > Trip indication LED for each arc fault sensor
- > Arc sensor supervision with sensor fail LED for each zone
- > 10Base-T / 100Base-TX port
- > Optional 100Base-FX port
- > System configuration via web browser
- > IEC61850 GOOSE capable
- > Up to 16 independent arc fault SARC logic nodes
- > Self-supervision watchdog with healthy LED and alarm contact
- > Wide range auxiliary supply
- > Surface mount or flush mount options

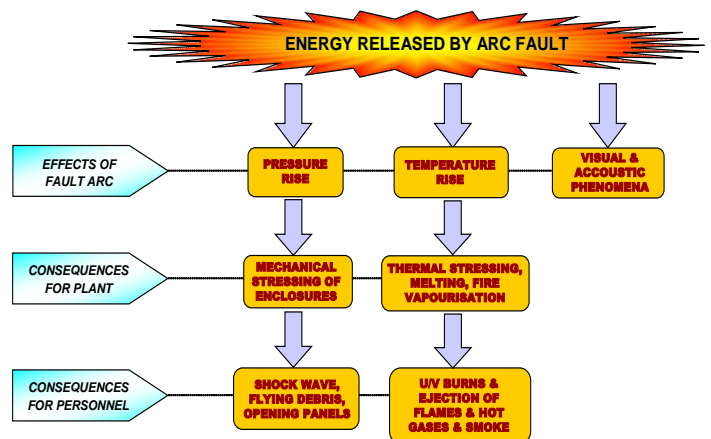

Figure 2: Energy release due to electrical arcing faults

## Arc Fault – Cause and Effect

Medium voltage switchgear and associated bus bars are a key element in the power supply chain. Existing protection systems operate effectively and quickly under most fault types but arcing faults may lead to slow operating times.

Due to the resistive nature of an arcing fault the associated fault current is likely to be lower than for a bolted short circuit.

Instantaneous overcurrent protection is set to operate above network energization currents and motor starting currents, the fault current due to an arc may be lower than this.

The consequence of these conditions is that a protection system based solely on over-current detection cannot effectively discriminate between normal system currents and an arc fault condition:

- > Moderate to low arc fault currents may not operate the instantaneous trip stage of a standard over-current relay
- > For a Moderate to low arc fault current the trip time of the over-current IDMT stage will be too slow

Arcing faults in metal clad switchgear and associated Bus bars may occur for a number of reasons:

- > defective or ageing insulating materials
- > poor bus or cable connections
- > poor maintenance
- > human error
- > ingress of moisture, dust or vermin
- > abnormal service conditions

The degree of damage caused by arcing depends principally on the duration of the arc. If an arc lasts only 100ms, the switchgear needs to be checked and the insulation resistance measured before power can be re-established. With a 200ms arc, the power supply will be interrupted; the switchgear must be checked; power is re-established only after minor repairs. In the event of a 500ms arc the supply is interrupted; metal parts of the switchgear are destroyed and poisonous gases are emitted. A 1s arc destroys most of the switchgear and may cause a fire, injury to personnel and damage to property.

## Arc Flash Detection Principal

An arcing fault results in an intense and rapid discharge of light from the arcing source. The light discharged from an arcing fault will typically be several thousand times normal ambient lighting levels.

The 1S24 ARC Fault Detection system optically senses the presence of an ARC by the means of 1S30 optical sensors connected to the 1S24 monitor.

Very fast ARC detection is achieved using this technique, and protection operation times of <10ms are achievable.

## Arc Fault Protection with Current Check

For system security purposes, the optical ARC detection may also be supervised by an external Instantaneous Current Check element to confirm fault detection.

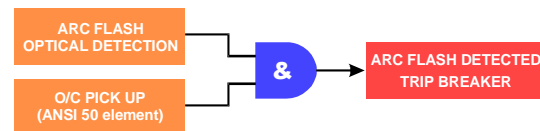

Figure 3: High speed AND logic employed to discriminate an arc flash fault

Arc fault protection compliments existing conventional overcurrent and differential protection schemes and is easily implemented into both new and existing installations.



Figure 4: Consequences of arcing faults

# 1S24 - Arc Fault Protection

## Arc Sensor Location

The number and location of optical arc sensors is dictated by the switchgear and Bus bar design and the length of the switchboard. In most indoor metal clad switchgear, the bus bar chamber is a continuous chamber between panels only broken into segregated sections at a bus section breaker and as such the strategic placement of one or two arc sensors in each bus bar chamber run is normally adequate.

Some indoor metal clad switchgear may segregate the bus chamber of each panel from the next via insulated bus chamber side barriers per panel, if this is the case then each bus chamber per panel would need to be monitored by at least one arc sensor.

Isolating switches between BUS bar sections need to also be considered and appropriate tripping zones created to ensure isolation of the faulted section.

In large enclosures the arc sensors should be placed at approximately 5m intervals. 1S30 arc sensors are also available with dual optical detectors to allow detection of an arc in both directions.

## IEC61850

Substations, power plants and distributed energy resources all over the world are now implementing protection, control, automation and condition monitoring functions in Power Automation Systems (PAS) according to the IEC61850 Standard.

The open architecture and high-speed GOOSE messaging available through the implementation of IEC61850 make it an ideal platform on which to base a scalable, selective and flexible arc fault protection scheme for any power system configuration.

The 1S24 system provides a comprehensive solution for the protection of arcing faults in metal clad air insulated switchgear and bus bar systems based on the IEC61850 Standard.

The arc is detected using an optical sensor and the signal input to the 1S24 arc monitoring system. The 1S24 generates IEC61850 GOOSE messages which are broadcast via the station bus LAN. Intelligent IED's are employed to subscribe to the arc fault GOOSE messages and generate tripping signals to the appropriate circuit breakers based on tripping logic that considers pre-determined system configurations. The 1S24 may be connected directly to an IED using a cross over cable or alternatively through a Station Bus Lan as per the typical IED topology shown in Fig 5.

An IEC61850 based Arc Fault Solution will achieve reduced engineering overhead compared to a conventional hard-wired alternative.

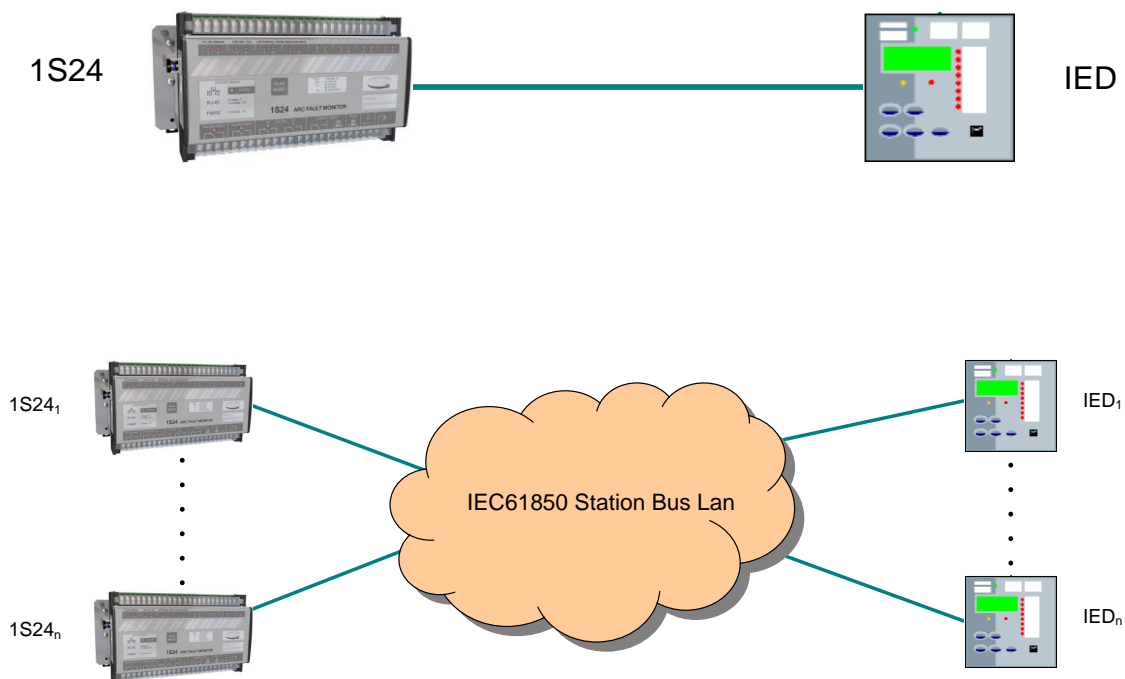

Figure 5: IEC based arc fault solution

# 1S24 - Functional Description

## Web Based Configuration

Configuration of the 1S24 Arc Fault Monitor is carried out using a web browser interface as depicted in the screen shots shown in figures 6 and 7. Connection is made between the 1S24 and a PC using a standard Category 5 patch cable with RJ45 electrical plugs.

Connect the 1S24 port P1 to the PC Ethernet LAN port.

Open a PC browser using the default IP address 192.168.0.220

## Ethernet Configuration

The current status of the relay comms. configuration is shown.

SNTP Server	Change SNTP server name (SNTP server of the Station Bus Lan)
SNTP re-sync.	Changes re-sync. time in seconds
Password	Change administration password

Any changes are password protected and require entry of the Username (admin) and the Password (Default from the factory is RMS).

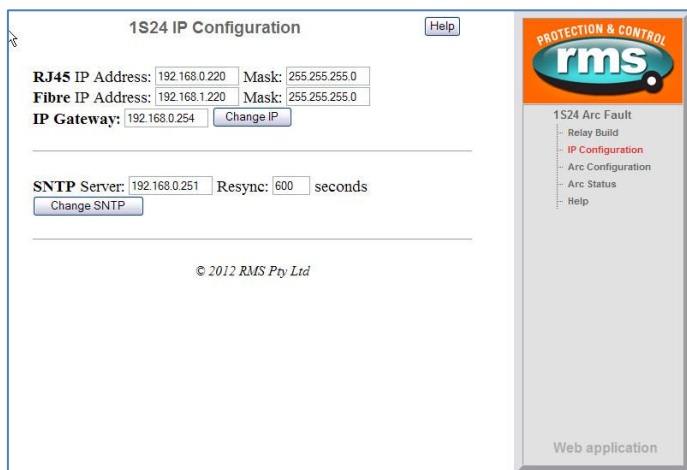

Figure 6: 1S24 IP Configuration screen

## Arc Configuration Screen

The current status of each ARC detector is shown. To make the web page follow the ARC status in real time, tick the Automatic refresh button.

## Arc Configuration

Each individual ARC sensor can be configured as follows:  
Armed or Disabled by clicking on the state column  
(Includes both IEC61850 Goose and the trip outputs)

## Arc States

The following list defines the possible ARC states:

- > Disabled: Sensor not connected or disabled
- > Armed: Ready to detect an ARC fault
- > Failed: ARC sensor supervision failure
- > Tripped: ARC detected
- > Initializing: ARC sensor initializing (transitory)
- > Stuck: ARC sensor stuck on
- > Included: Determines whether a sensor is allocated to the relay
- > Trip outputs (Yes or No)

Each individual ARC sensor provides the following status:

- > Trip: Indicates when the ARC LED Flag is asserted (Yes or No)
- > Count: Retains a count since power on of how many times ARC sensor has been tripped. This count can be reset to 0 by clicking on the counter.

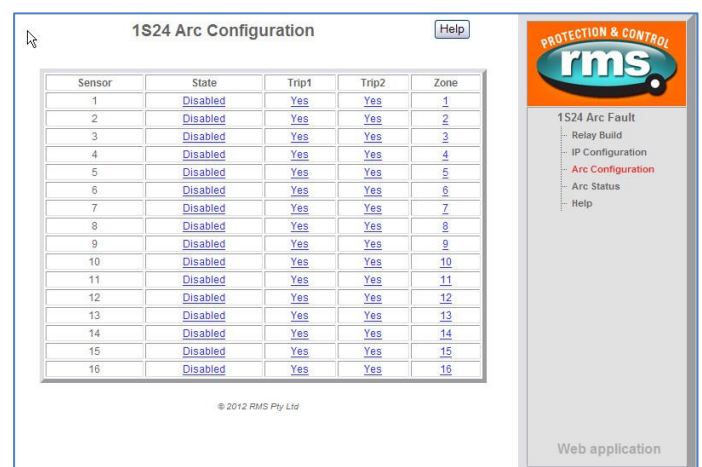

Figure 7: 1S24 Arc Sensor Configuration screen

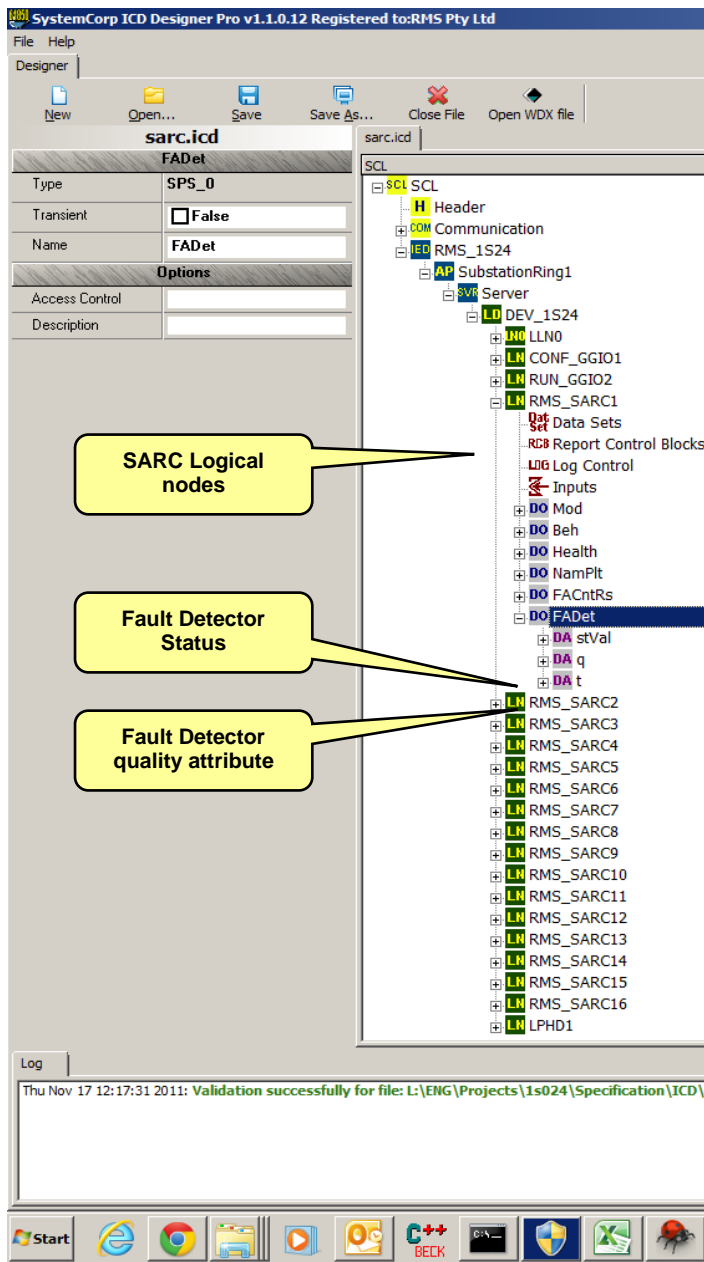

Figure 8: ICD editing screen

## IED Capability Description (ICD)

The ICD is utilised in IEC61850 Substation Project Development.

The 1S24 ICD model contains the following logical nodes:

A standard IEC61850-5 SARC (Monitoring and diagnostics for arcs), for each of the 16 Arc detectors. These cover an individual Arc fault detection, fault counter and detector health. Also, each Arc detector can be enabled or disabled using the SARC Mode.

A configuration GGIO that can be used to configure the inclusion of each Arc detector in the single Alarm output relay of the 1S24, as an alternative to the web page.

A run-time GGIO that allows the front panel LED state for each Arc detector to be observed and cleared via IEC61850, as well as observing the state of the Alarm and Sensor Fail relays remotely.

A Logical Node 0 (LLN0), that observes name plate information about the device and overall device current behaviour. A global block can be set and unset via IEC61850 using the LLN0 Mode.

The structure of the ICD file is depicted in figure 7 and may be viewed using third party ICD browsers.

# 1S24 - Functional Description

## IEC61850 Project

The IEC61850 standard permits the integration of the 1S24 into a substation project incorporating any third-party CB management IED.

The 1S24 is modelled under IEC61850 with a Logical node model defined by a 1S24.icd file. This file can be imported into your IEC61850 system configurator and incorporated into an IEC61850 project.

Examples of an IEC61850 Substation project incorporating a 1S24 into an ARC Fault Protection scheme and CB Management Logic utilising subscribed Goose messages from the 1S24 are shown in Figures 8 and 9.

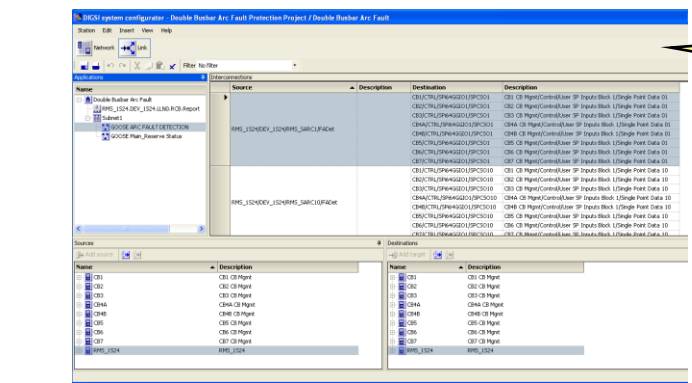
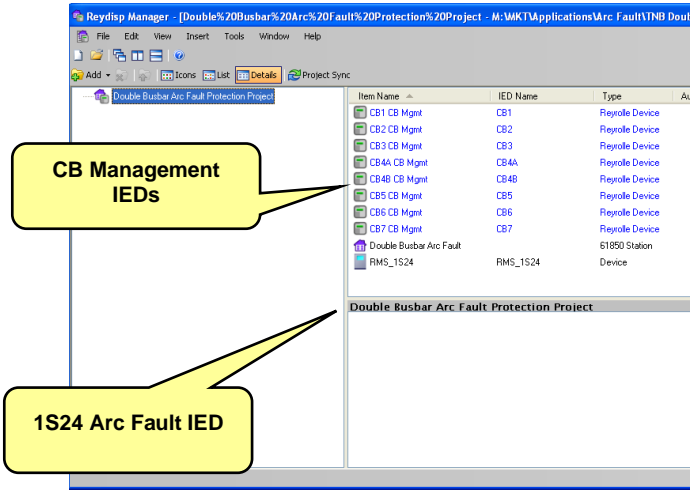

IEC61850 Configurator such as DIGSI used to create Goose interconnections between IEDs

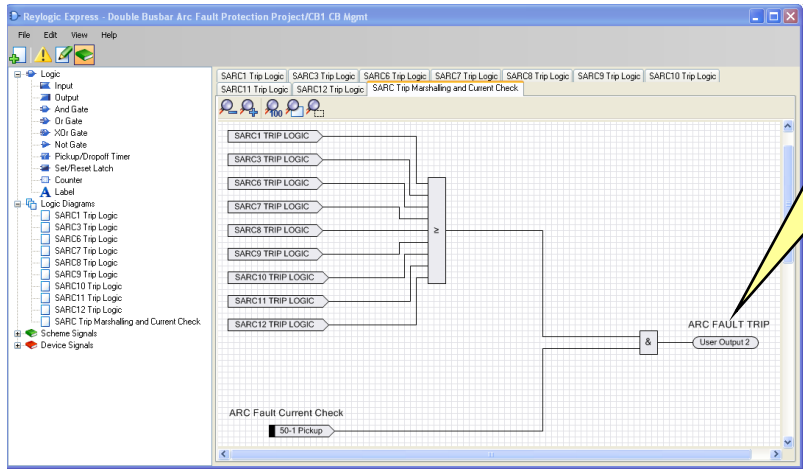

Example of SARC Trip Marshalling and Current Check logic implemented in a CB management relay

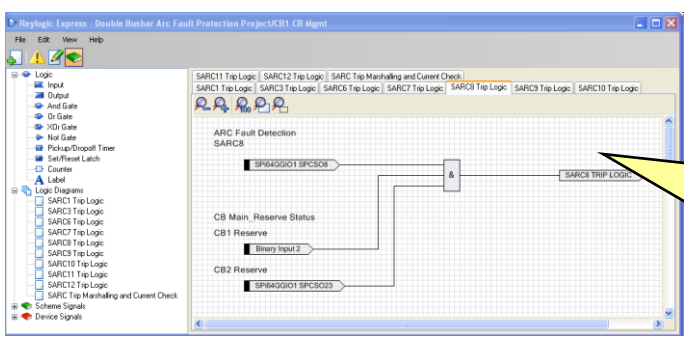

Example of CB Management SARC Trip Logic making use of subscribed Goose messages from the 1S24

Figure 9: IEC61850 project editing screens

# 1S24 - Functional Description

## Arc Sensor Function

The 1S30 is an optical sensor that responds to the flash of light emitted during the incidence of an arcing fault. Onset of the light flash and detection by the 1S30 occurs in a few ms.

Refer to the 1S30 Technical Bulletin for further details.

## 1S30 Point Sensor Inputs and Indicators

A red LED is provided for each arc sensor input to indicate:

- Trip:** LED illuminates solid on detection of an arc fault.  
Resets when the front panel reset button is pressed or voltage pulse applied to remote reset status input. Individual flags can also be observed and cleared via IEC61850.
- Fail:** LED Flashes to indicate failure of 1S30 Arc Fault Sensor in zone.

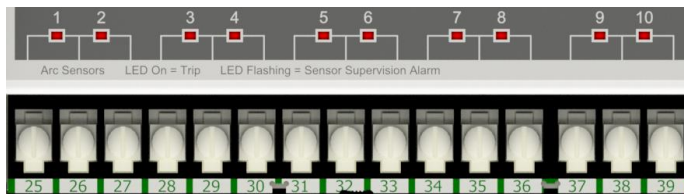

Figure 10: Point arc sensor LED's and terminals

## 1S40 Linear Sensor Inputs

Two 1S40 linear sensor connection ports are provided where this option is specified.

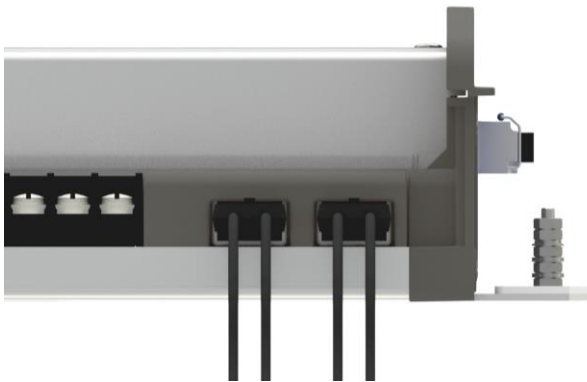

Figure 11: Linear arc sensor connection ports

## Auxiliary Supply

A single green LED is provided to signal when an auxiliary supply is connected and the 1S24 energised.



Figure 12: Auxiliary supply healthy LED

## Arc Trip Output Contacts

The 1S24 provides two (2) or three (3) high speed tripping output contacts. These may be employed for local tripping functions and for system testing purposes. Each sensor input may be set to trip either of the output contacts.

The arc trip contacts will self-reset after a 2s delay. The trip indication LED is reset either by pressing the front panel reset button, via the remote reset status input or via IEC61850 control.

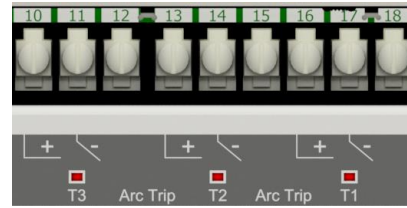

Figure 13: Arc trip output contacts and trip LED

## Arc Trip Blocking Input

The 1S24 provides a status input to enable a global block of all arc fault detection sensors. Application of a control voltage within the specified range will activate this function and energize the Global Arc Block LED.



Figure 14: Global arc block input and LED indication

## Arc Detection Reset Time

### Effect of multiple arc trips

A delay of 2s is required to reset the 1S24 after an initial arc sensor trip. Subsequent arc detection will cause the trip outputs to re-operate.

## Remote Reset

A remote reset status input is provided to reset the arc trip LED's.



Figure 15: Remote reset binary input and flag reset



## 1S30 Point Sensor Supervision

To monitor the integrity of the wiring between the 1S30 arc sensor and 1S24 Arc Monitor, continuous 2mA supervision current flows between the units.

If the sensor supervision current is not detected for 1s the Sensor Alarm contact will operate and the Sensor Alarm LED will illuminate solid.

The affected sensor(s) will be indicated by the front panel sensor LED 1-16 flashing. The associated IEC61850 Arc Fault Quality will change to questionable.

## 1S40 Linear Sensor Supervision

To monitor the integrity of the 1S40 arc sensor a periodic light pulse is transmitted from the 1S24 Tx port. This light pulse travels the length of the 1S40 linear sensor and is received at the 1S24 Rx port to confirm the integrity of the 1S40 sensor. Internal logic is employed in the 1S24 to ensure that arc trips are masked during the self-test cycle.

If the return pulse is not detected the Sensor Alarm contact will operate, the Sensor LED flash and the associated IEC61850 Arc Fault Quality will change to questionable.

The 1S40 arc sensors are automatically calibrated at system power up. If the calibration process fails, the Cal LED will be illuminated and the Trip LED flash indicating an alarm condition.

Refer to the 1S40 Technical Bulletin for details on how to configure the 1S24 for correct operation.

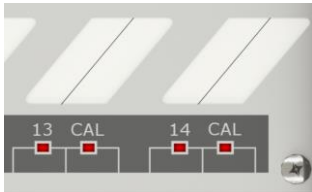

Figure 16: Front panel 1S40 linear sensor LED's

The status of the linear sensors is indicated by the four (4) LED's on the 1S24 front panel as per table 1.

1S40 Sensor LED's				
Sensor 13		Sensor 14		
13	Cal	14	Cal	
Flash	Solid	Flash	Solid	Calibration Fail
Flash	-	Flash	-	Sensor Fail Alarm
Solid	-	Solid	-	Arc Trip

Table 1

## Arc Sensor Continuously Picked Up

High ambient light levels may cause a 1S30 or 1S40 to be continuously picked up. This condition could occur for example if the CB cable box cover was left open in very high ambient light level conditions. A non-arc fault over-current pick up would then result in an arc fault trip operation.

To avoid possible mal operation due to this condition, the 1S24 is designed to automatically disable the arc fault tripping function if the 1S30 or 1S40 sensor is picked up for >10s. The 1S24 Sensor Alarm contact will operate and Sensor Alarm LED will illuminate solid until the ambient light level problem is corrected. The 1S24 will then perform an arc sensor test function and automatically reset.

The effected sensor(s) will be indicated by the front panel sensor LED 1-16 flashing.

## Sensor Fail Alarm

A common Sensor Fail Alarm contact is provided.

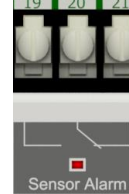

Figure 17: Sensor fail alarm LED and output contact

## Self-Supervision Service Alarm

A C/O alarm contact is maintained in the energized state when all of the following conditions are met:

The auxiliary supply is applied

The internal 5V DC rail is within acceptable limits

The CPU hardware watchdog maintains a pulsing output

The Service Alarm LED will be energized for a CPU fail condition.



Figure 18: Self-supervision service alarm

# 1S24 - Functional Description

## Rating Plate and Flag Reset

The rating plate is clearly identified on the front panel. A reset button is provided to reset the arc trip LED's. This button also has other functions to initiate warm boot and cold boot to restore factory default settings. Refer to the User Guide for details.

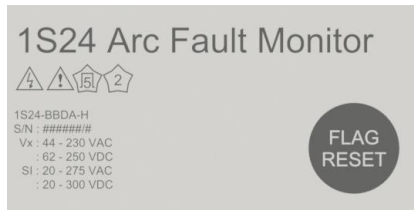

Figure 19: Relay rating plate and reset button

## Customer Labelling

The 1S24 front panel has provision for two (2) custom labels. Custom labels may be produced using the template provided on the RMS web, printed and slipped behind the clear windows on the front panel as depicted below.

Alternatively, the default label may be marked up by hand. This allows identification of arc sensor positions and details such as the 1S24 IP address.

[https://www.morssmitt.com/uploads/files/catalog/products/1s24-slide-label-template\(1\).docx](https://www.morssmitt.com/uploads/files/catalog/products/1s24-slide-label-template(1).docx)

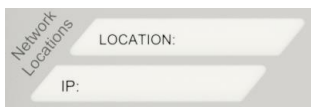

Figure 20: Slide in label for 1S24 location and IP address



Figure 21: Slide in label for arc sensor location

## Ethernet Communication Port(s)

The 1S24 provides two (2) high speed Ethernet port options for connection to an IEC61850 compliant station bus local area network (LAN).

### Standard Port

The standard port employs an electrical interface with an RJ45 connector and supports 10Base-T / 100Base-TX. The port may be utilised for either IEC61850 Goose messaging purposes or for device configuration.

### Optional Second Port

An optional second port employs a plug-in optical fibre port and supports 100Base-FX.

The two-port option allows one of the ports to connect to an IEC61850 station bus LAN for Goose messaging purposes and either port may be utilised for device configuration.



Figure 22: Standard single port 10Base-T / 100Base-TX



Figure 23: Optional dual port 10Base-T / 100Base-TX + 100Base-FX

## Communications Status

LED's are provided to indicate auxiliary supply and Ethernet activity.

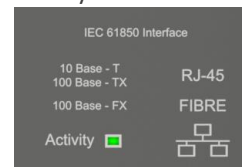

Figure 24: System status LED's

## Chassis Earth



Figure 25: Chassis earth terminal

# 1S24 - Application Diagram

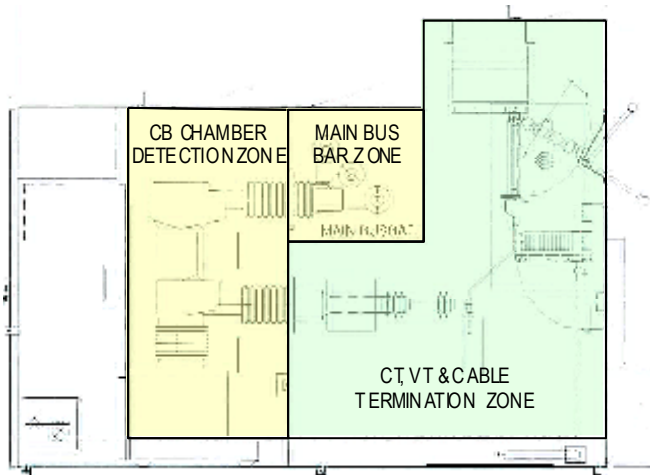

Figure 26: Single bus circuit breaker

## Single Bus Switchgear

Single Bus Bar switchgear systems are prevalent at medium voltage levels. The complexity on the protection required to mitigate arc flash faults is dependent on the Bus configuration. Figure 26 depicts a typical circuit breaker arrangement in a single bus scheme.

## Single Bus and Switchgear Arc Protection

Figure 27 depicts how the 1S24 may be applied for arc fault protection on a single bus bar configuration.

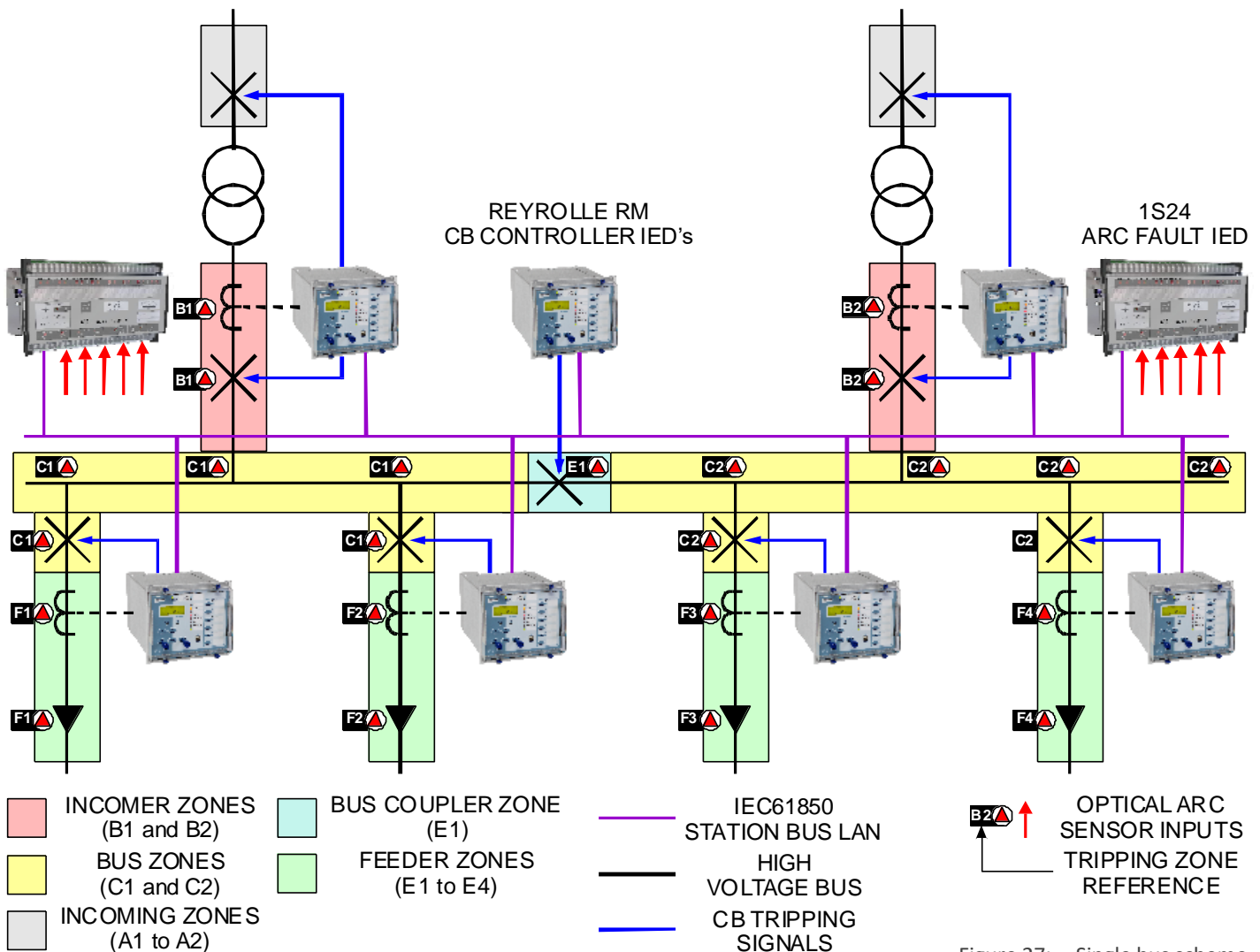

Figure 27: Single bus scheme

# 1S24 - Application Diagram

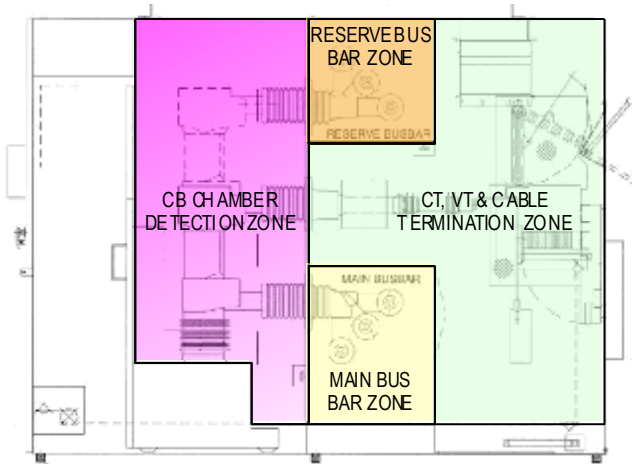

Figure 28: Single bus circuit breaker

## Dual Bus Switchgear

Double Bus Bar switchgear systems present additional challenges for protection against arc flash faults due to the number of arc fault protection zones and multiple operating configurations possible. Figure 28 depicts a typical circuit breaker arrangement in a double bus scheme.

## Double Bus and Switchgear Arc Protection

Figure 29 depicts how the 1S24 may be applied for arc fault protection on a double bus bar configuration.

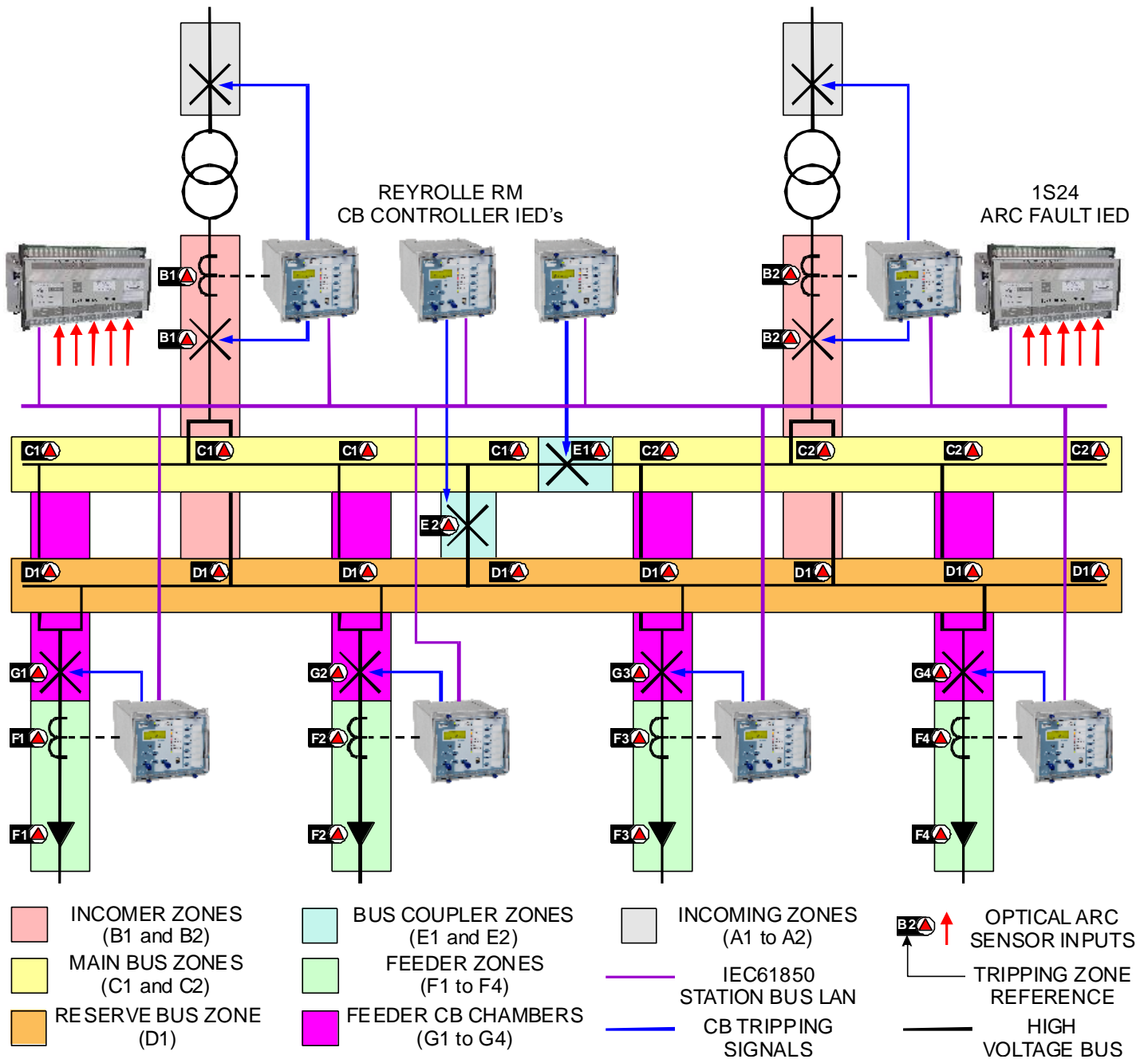

Figure 29: Double bus scheme  
1S24/ J / 26/07/2022 - 12/25

# 1S24 - Technical Data

## Auxiliary Supply

Low Range Version	Order Code A
Nominal dc Voltage Supply	48
Standards Compliant Range (Shown on relay front panel)	40-58V dc
Absolute Range	20-70V dc
High Range Version	Order Code B
Nominal dc Voltage Supplies	110 / 125 / 220 / 240 / 250
Standards Compliant Range (Shown on relay front panel)	62-250V dc 44-230V ac 50/60 Hz
Absolute Range	40-300V dc 40-275V ac 50/60 Hz
Burden - Quiescent	8W at 110V dc
Burden - Maximum	15W at 110V dc

## Binary Inputs

Operating Range	18-275V ac / 17-290V dc
Operating Current	10mA pickup for 1ms Reducing to 1.5mA after 4ms
DC Operate Time	<4ms pickup <16ms dropout
AC Operate Time	<23ms pickup <33ms dropout
Function	Enable on the application of the control voltage

## Standard Trip Outputs

Operating Voltage	Voltage free
Operating Mode	Self-reset
Trip Contact Operate Time	8-9ms (Flash to contact closure)
Reset Time	2s
Making Capacity	
Carry Continuously	5A ac or dc
Make and Carry L/R ≤ 40ms and ≤ 300V	20A ac or dc for 0.5s 30A ac or dc for 0.2s
Breaking Capacity	L/R ≤ 40ms and ≤ 300V
AC Resistive	1,250VA
AC Inductive	250VA at p.f. ≤ 0.4
DC Resistive	75W
DC Inductive	30W at L/R ≤ 40ms 50W at L/R ≤ 10ms
Minimum Load	100mA ≥12V

## Hybrid High Speed Trip Output Option

Specifications as per the standard trip outputs except:	
Switching Polarity	DC only
Trip Contact Operate Time	<2.2ms (Flash to contact closure)
Reset Time	2s
Breaking Capacity	20A dc

## Arc Fault Point Sensor Inputs

Number	12 or 16
Type	1S30 point sensors
Connection	Electrical termination
Zones	Up to 16
Supervision duration	Continuous

## Arc Fault Linear Sensor Inputs

Number	0 or 2
Type	1S40 linear sensors
Connection	Rx and Tx optic fibre ports
Zones	Up to 2
Supervision duration	<1ms
Supervision interval	Settable to 1, 2, 5, 15 or 30 min.

## Goose Response

GOOSE Response Transfer Time	Type 1A, Class P1
End to end timing (From flash to 1S24 GOOSE publication to Omicron CMC356 GOOSE subscription)	Single SARC GOOSE 5.5ms

## ELECTRICAL ENVIRONMENT

### AC and DC Voltage Dips

Standard	IEC 60255-26, #7.2.11
Test Level	Test specification
Dip to 0% of residual voltage Acceptance criterion A	DC: 20 ms AC: 1 cycle 50/60 Hz
Dip to 40% of residual voltage Acceptance criterion C	DC: 200 ms AC: 10/12 cycles 50/60 Hz
Dip to 70% of residual voltage Acceptance criterion C	DC: 500 ms AC: 25/30 cycles 50/60 Hz

### AC and DC Voltage Interruptions

Standard	IEC 60255-26, #7.2.11 Acceptance criterion C
Test Level	Test specification
Drop to 0% of residual voltage	DC: 5 s AC: 250/300 cycles 50/60 Hz

### AC Component in DC (Ripple)

Standard	IEC 60255-26, #7.2.12 Acceptance criterion A
Test Level	Test specification
15% of rated DC value	100/120 Hz, Sinusoidal

### Gradual Shut-down/Start-up (DC Power Supply)

Standard	IEC 60255-26, #7.2.13 Acceptance criterion C
Test Identification	Test specification
Shut-down ramp	60 s
Power off	5 min
Start-up ramp	60 s

### Clearances and Creepage Distances

Standard	IEC 60255-26, #10.6.3
Test Identification	Test specification
Pollution degree	2
Overvoltage category	III
Rated insulation voltage	300 V rms or d.c.
Clearances and Creepage Compliance	CAD drawings assessment

## Safety-related Electrical Tests

Standard	IEC 60255-27, #10.6.4
Test Identification	Test specification
Between Independent Circuits	5 kV 1.2/50 $\mu$ s 0.5 J 3 pulses of each polarity 2.0 kV ac rms for 1 minute
Any Terminal and Earth	5 kV 1.2/50 $\mu$ s 0.5 J 3 pulses of each polarity 2.0 kV ac rms for 1 minute
Across Normally Open Contacts	1 kV ac rms for 1 min
Protective Bonding Resistance	< 0.1 $\Omega$ at 20 A

## Electrical Environment and Flammability

Standard	IEC 60255-27, #10.6.5
Test Identification	Test specification
Single-fault condition	Assessment
Maximum temperature of accessible parts at ambient temperature +40°C	Metal parts: < 70°C Non-metallic parts: < 80°C
Flammability of insulating materials, components and fire enclosures	Assessment

## Reverse Polarity and Slow Ramp Test

Standard	IEC 60255-27, #10.6.6
Test Identification	Test specification
Maximum voltage d.c.	V start-up + 20%
Minimum voltage d.c.	V shutdown - 20%
Ramp down/up gradient	1 V/min

# 1S24 - Compliance Data

## ATMOSPHERIC ENVIRONMENT

### Temperature

Standard	IEC 60068-2-1, IEC 60068-2-2	
Test Identification	Test specification	Auxiliary power Supply voltage
Operating Range	-10 to +55°C	Min and Max
Storage Range	-25 to +70°C	Non-energized
Test duration	16 h at top and bottom temperatures	

### Damp Heat (Humidity)

Standard	IEC 680068-2-78	
Test Identification	Test specification	
Operating Range	40°C and 93% RH non-condensing	
Test duration	16 h	

### IP Rating

Standard	IEC 60529	
Test Identification	Test specification	
Installed	Enclosure: IP5x Terminals: IP1x	

## MECHANICAL ENVIRONMENT

### Vibration - Sinusoidal

Standard	IEC 60255-21-1 Class 1	
Test Identification	Test specification	Variation
Vibration Response in each of 3 axes	0.035 mm/0.5 gn peak 1 sweep cycle 10-150 Hz	No Mal-Op
Vibration Endurance in each of 3 axes	1.0 gn peak 20 sweep cycles 10-150 Hz	Non- energized

### Shock and Bump

Standard	IEC 60255-21-2 Class 1	
Test Identification	Test specification	Variation
Shock Response in each of 3 axes	5 gn, 11 ms, 3 pulses in each direction	No Mal-Op
Shock Withstand in each of 3 axes	15 gn, 11 ms, 3 pulses in each direction	Non- energized
Bump Test in each of 3 axes	10 gn, 16 ms, 1,000 bumps in each direction	Non- energized

### Seismic

Standard	IEC 60255-21-3 Class 1	
Test Identification	Test specification	Variation
Seismic Response Horizontal, on each axis	3.5 mm/1.0 gn, 1 sweep cycle 1-35Hz	No Mal-Op
Seismic Response Vertical	1.5 mm/0.5 gn, 1 sweep cycle 1-35Hz	No Mal-Op

## ELECTROMAGNETIC COMPATIBILITY (EMC)

### IMMUNITY

#### Electrostatic Discharge (ESD)

Standard	IEC 60255-26, #7.2.3, Acceptance criterion B	
Port	Enclosure	
Test Identification	Test specification	Variation
Contact Discharge	6 kV	No Mal-Op

#### Radiated Electromagnetic Field

Standard	IEC 60255-26, #7.2.4, Acceptance criterion A	
Port	Enclosure	
Test Identification	Test specification	Variation
Frequency sweep	10 V rms, 80 to 1000 MHz 1400 to 2700 MHz	No Mal-Op
Spot frequencies	10 V rms, 80, 160, 380, 450, 900, 1850 & 2150 MHz	No Mal-Op

#### Fast Transients (EFT)

Standard	IEC 60255-26, #7.2.5, Acceptance criterion B	
Port	Auxiliary power supply, Input and Output, Functional Earth	
Test level	Test specification	Variation
Zone A	4 kV peak, 5/50 ns, 5 kHz	No Mal-Op

#### Slow Damped Oscillatory Wave (HFD)

Standard	IEC 60255-26, #7.2.6, Acceptance criterion B	
Port	Auxiliary power supply, Input and Output	
Test Identification	Test specification	Variation
Common Mode	1 MHz 2.5 kV peak	No Mal-Op
Differential Mode	1 MHz 1.0 kV peak	No Mal-Op

### Surge

Standard	IEC 60255-26, #7.2.7, Acceptance criterion B	
Port	Auxiliary power supply, Input and Output	
Test Identification	Test specification	Variation
Line-to-earth	4 kV peak	No Mal-Op
Line-to-line	2 kV peak	No Mal-Op

## Conducted Disturbance Induced by RF Fields

Standard	IEC 60255-26, #7.2.8, Acceptance criterion A	
Port	Auxiliary power supply, Input and Output, Functional Earth	
Test Identification	Test specification	Variation
Frequency sweep	10 V rms, 0.15 to 80 MHz	No Mal-Op
Spot frequencies	10 V rms, 27 & 68 MHz	No Mal-Op

## Power Frequency Magnetic Field

Standard	IEC 60255-26, #7.2.10	
Port	Enclosure only	
Test Identification	Test specification	
Continuous $\geq 60$ s	30 A/m - Acceptance criterion A	
Short time 1 s to 3 s	300 A/m - Acceptance criterion B	

## EMISSION

### Emission Enclosure

Standard	IEC 60255-26, #5.1	
Test Identification	Frequency range	Limits, dB ( $\mu$ V/m)
Radiated emission <1 GHz	30 - 230 MHz	40, quasi peak at 10 m 50, quasi peak at 3 m
	230 - 1000 MHz	47, quasi peak at 10 m 57, quasi peak at 3 m
Radiated emission >1 GHz	1 - 3 GHz	56, average 76, peak at 3 m
	3 - 6 GHz	60, average 80, peak at 3 m

### Emission Auxiliary Power Supply Port

Standard	IEC 60255-26, #5.2	
Test Identification	Frequency range	Limits, dB ( $\mu$ V/m)
Conducted emission	0.15 - 0.50 MHz	79, quasi peak 66, average
	0.5 - 30 MHz	73, quasi peak 60, average



# 1S24 - Front Panel

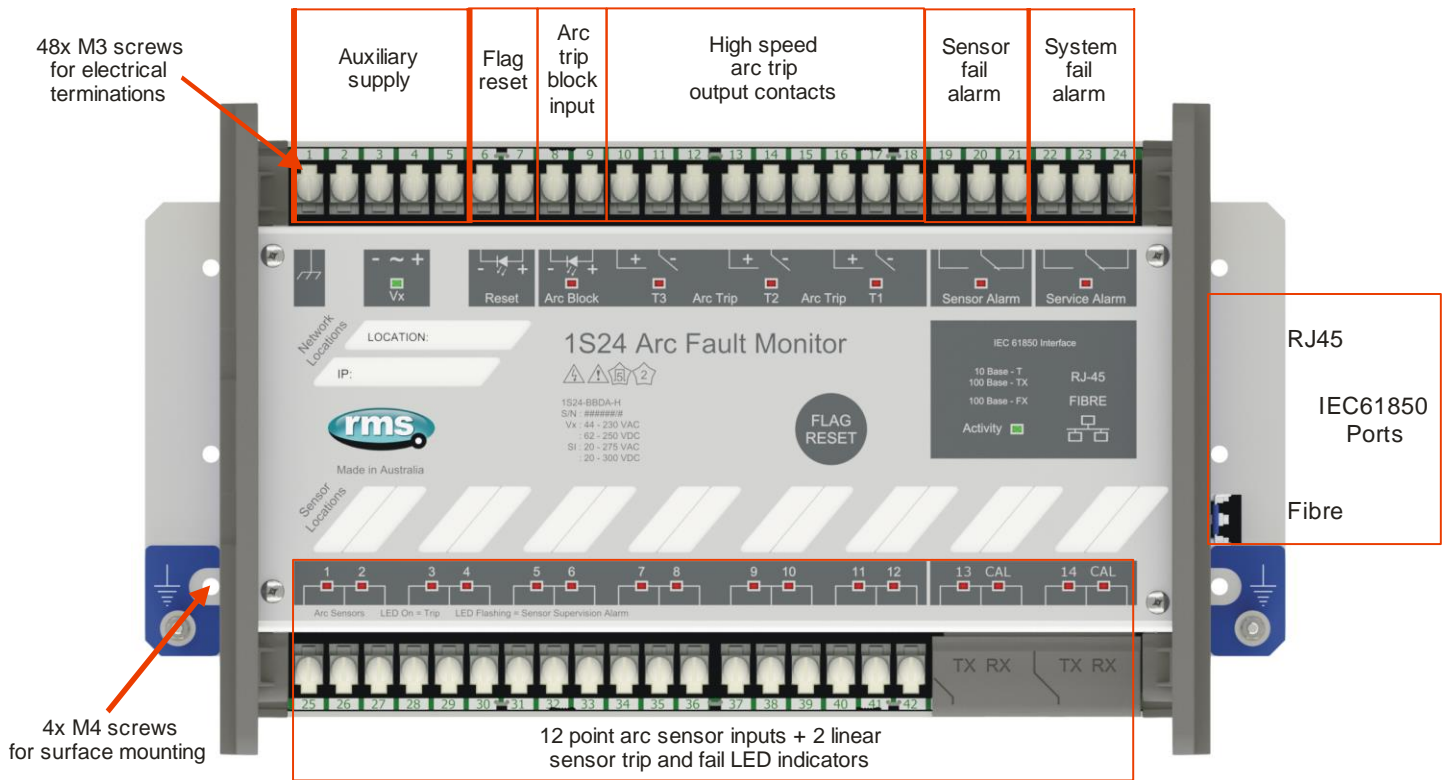

Figure 30: Front panel layout

## Rack Mount Version



Figure 31: Front panel layout - 12U wide including right angle RJ45 plug / socket

## Flush Mount Vertical Orientation

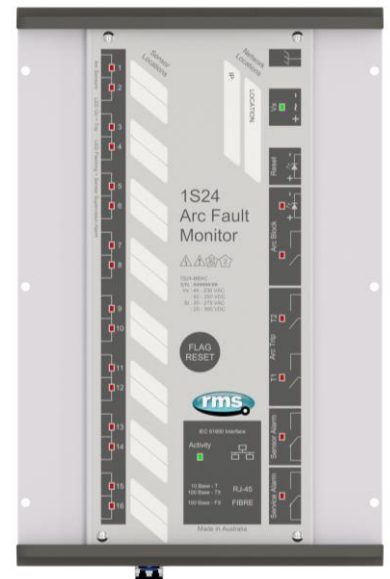

Figure 33: Vertical front panel layout



Figure 32: Rear terminal layout (Note the right angle RJ45 plug / socket fitted)

# 1S24 - Wiring Diagram

## Wiring and Termination

Figure 34 shows the wiring diagram for the 1S24 with 16 point sensors and 3 high speed trip outputs.

For models with 2 trip outputs, the output on terminals 10 and 11 operates as a N/O Arc Trip Block Repeat contact.

Details of the linear sensor connections are shown under the 1S40 Linear Fibre Sensor section – refer figures 30, 37 and 38.

Sturdy M3.5 screw terminals are provided suitable for one or two ring terminals. Multiple chassis earthing points are also provided.

Terminal numbering is clearly identified and graphics provided on the front panel to indicate the connection function.

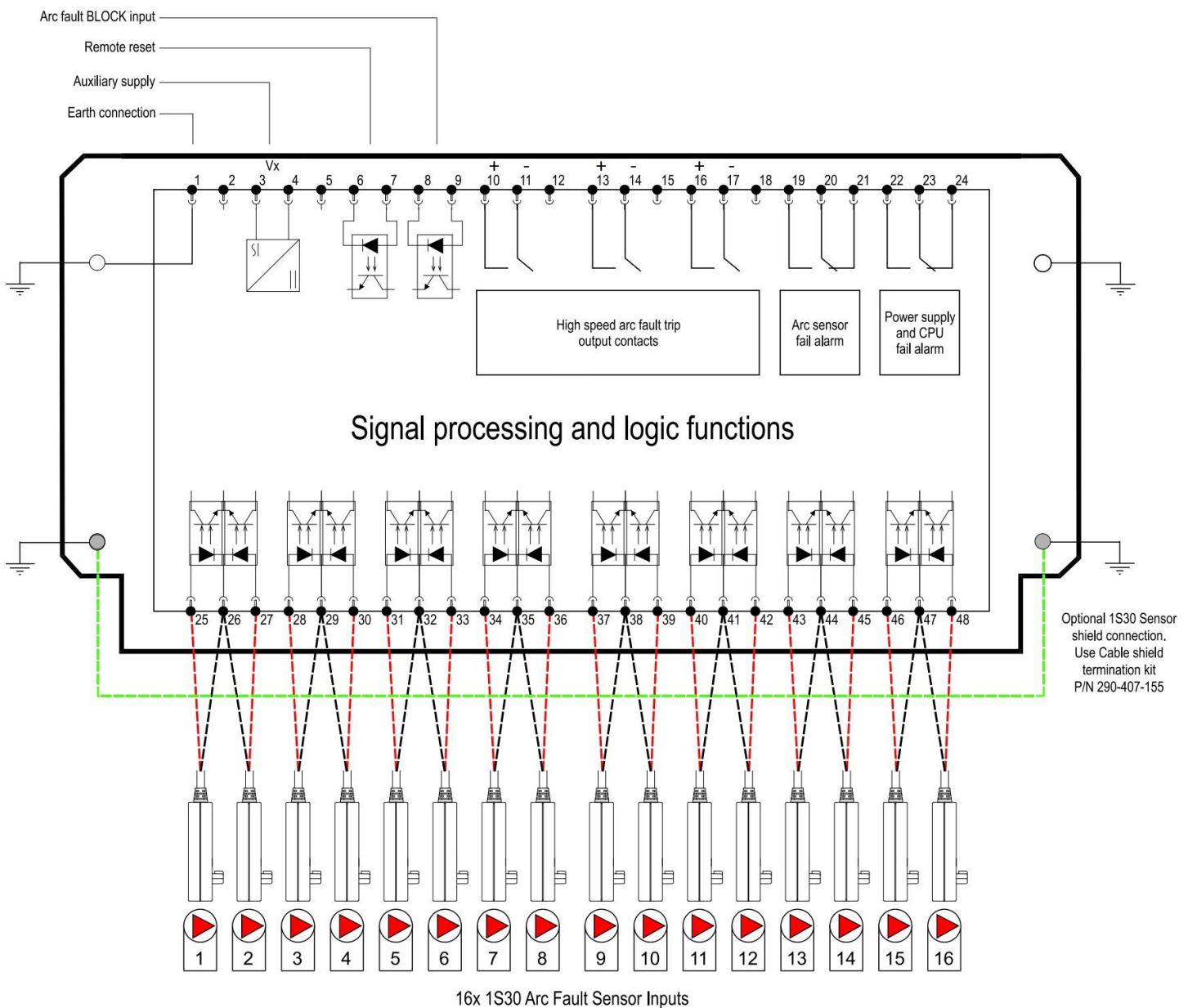

Figure 34: Wiring diagram – Relay de-energized

# 1S24 - Arc Sensors

## 1S30 Point Sensor Connection

12 or 16x 1S30 point arc sensor inputs are provided.

Each sensor operates independently with a common connection shared between each pair of sensors to reduce the total number of terminals required.

Each sensor pair is wired to 3 M3 terminal screws with the centre screw being common.

Figure 34 shows the wiring arrangement. The 1S30 sensor wires are colour coded but are not polarity sensitive.



Figure 35: 1S30 sensors

## 1S30 Shielded Cables

Shielded cables are recommended when the length of the 1S30 cable connections exceed 6m.

M3 earth studs with nuts and lock washers are provided on the 1S24 chassis in two (2) positions - one to the left of terminal 1 and one to the right of terminal 24 - to allow connection of the optional 1S30 sensor cable shields. Refer to figure 36 for connection details.

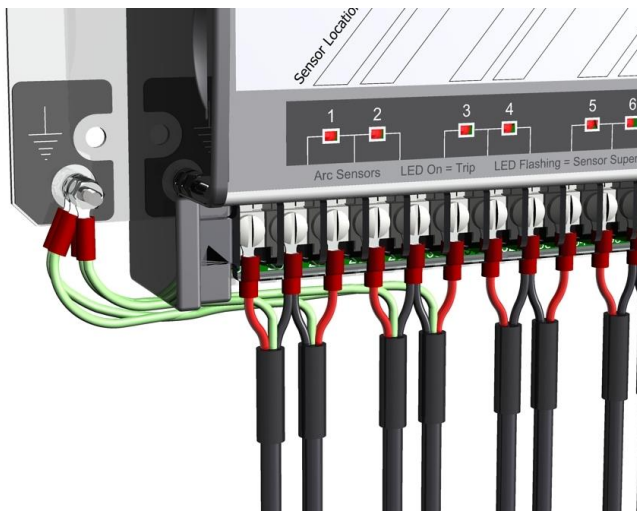

Figure 36: 1S30 sensor wiring using shielded cables

## 1S40 Linear Fibre Sensor

The 1S24 may be optionally specified to interface two 1S40 linear optic fibre sensors.

The 1S40 linear sensor may be applied to protect large volumes where multiple point sensors would otherwise be required. A separate 1S40 sensor is required for each protection zone.

Refer to the 1S40 Technical Bulletin for details on how to configure the 1S24 for correct operation.

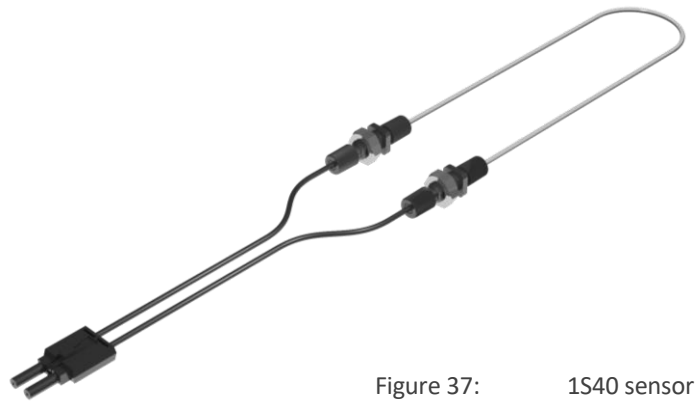

Figure 37: 1S40 sensor

## 1S40 Linear Fibre Connection

One end of each sensor is connected to Rx and the other end to Tx using the integrated screw clamp fittings.

When fitted, optical sensor connections 13 and 14 replace electrical terminals 43 to 48.

1S40 sensor 1: 13 - Tx 1 Cal - Rx 1

1S40 sensor 2: 14 - Tx 2 Cal - Rx 2

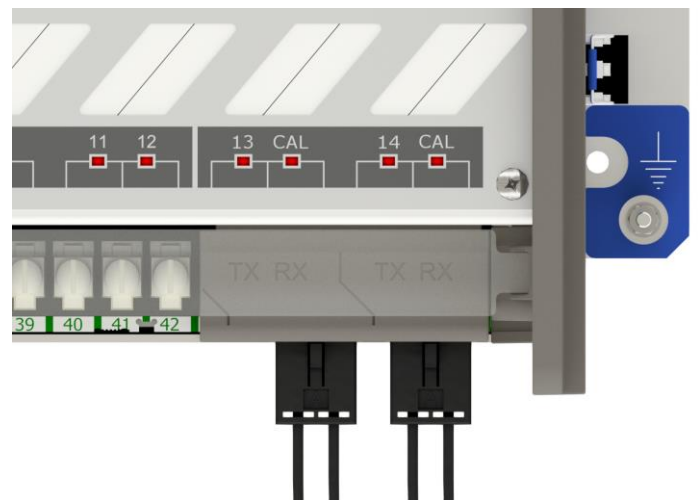

Figure 38: 1S40 Rx and Tx optic fibre connections

# 1S24 - Arc Sensors

## 1S40 Linear Fibre Sensor Configuration

The 1S24 arc monitor must be configured with the correct setting corresponding to the length of the optic fibre transmission section shown in figure 39 and listed in Table 2. The transmission section fibre must be cut to one of the set lengths as specified in Table 2 within a tolerance of 10%.

Configuration is achieved via the 1S24 web browser Fibre Loop Sensor Configuration screen as per figure 40.

Transmission Section Length	Setting
0 metres	<1
1 metres	1m
5 metres	5m
10 metres	10m
20 metres	20m
30 metres	30m
40 metres	40m

Table 2

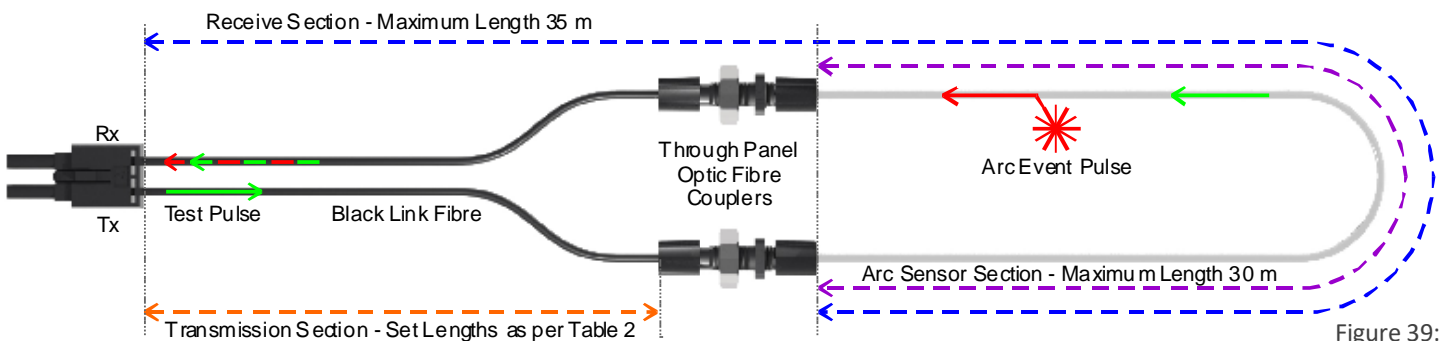
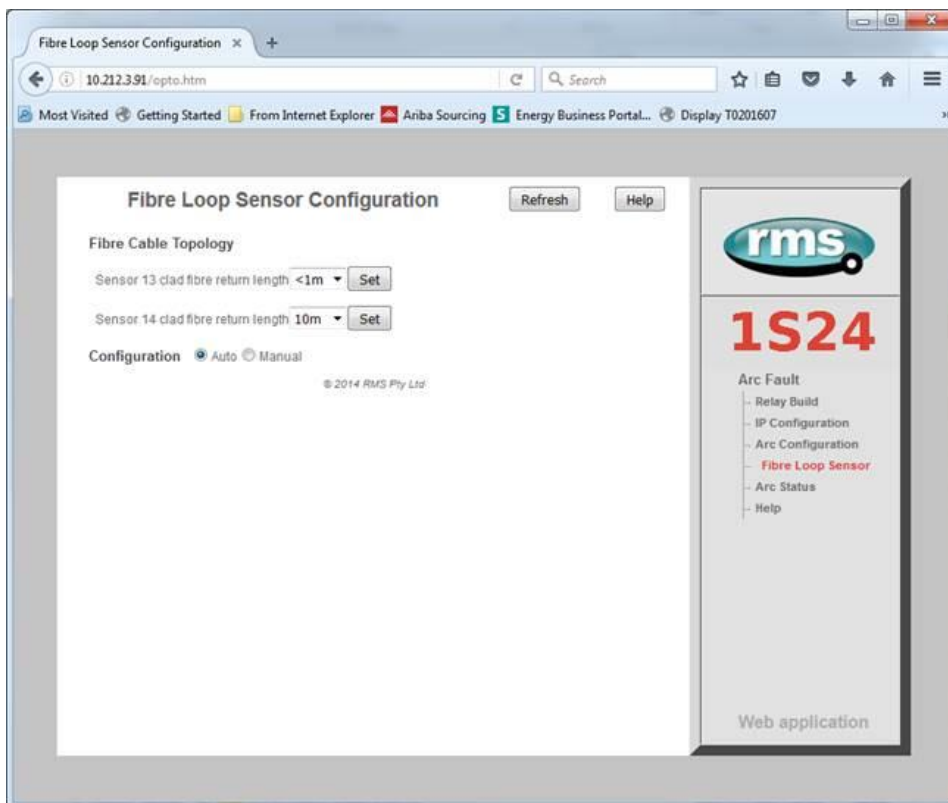

Figure 39:

1S40 Component Function and Installation Limitations



# 1S24 - Dimensions

## Surface or DIN Rail Mounting

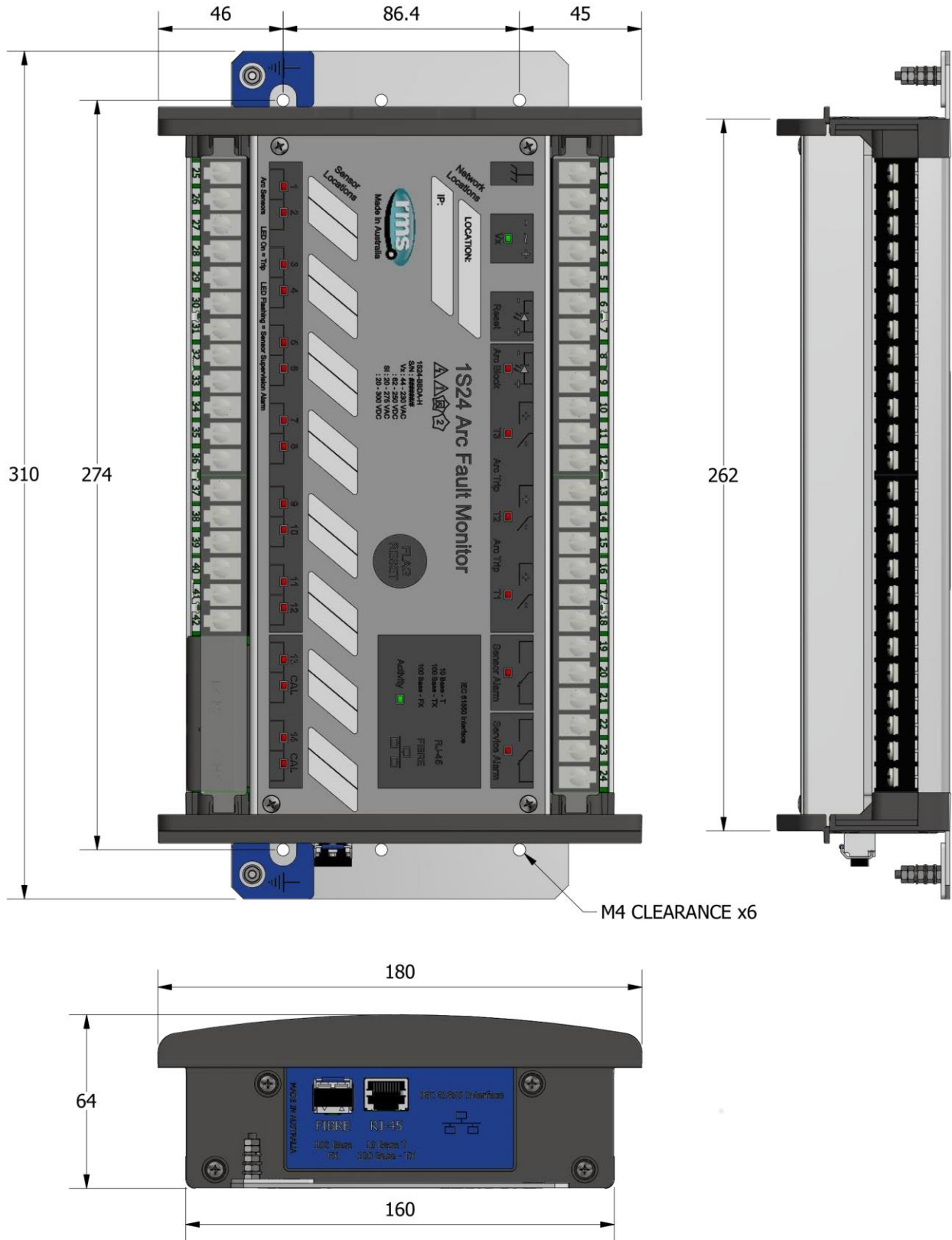

Figure 41: Surface and DIN Rail mount version dimensions

# 1S24 - Dimensions

## Panel or Rack Mounting

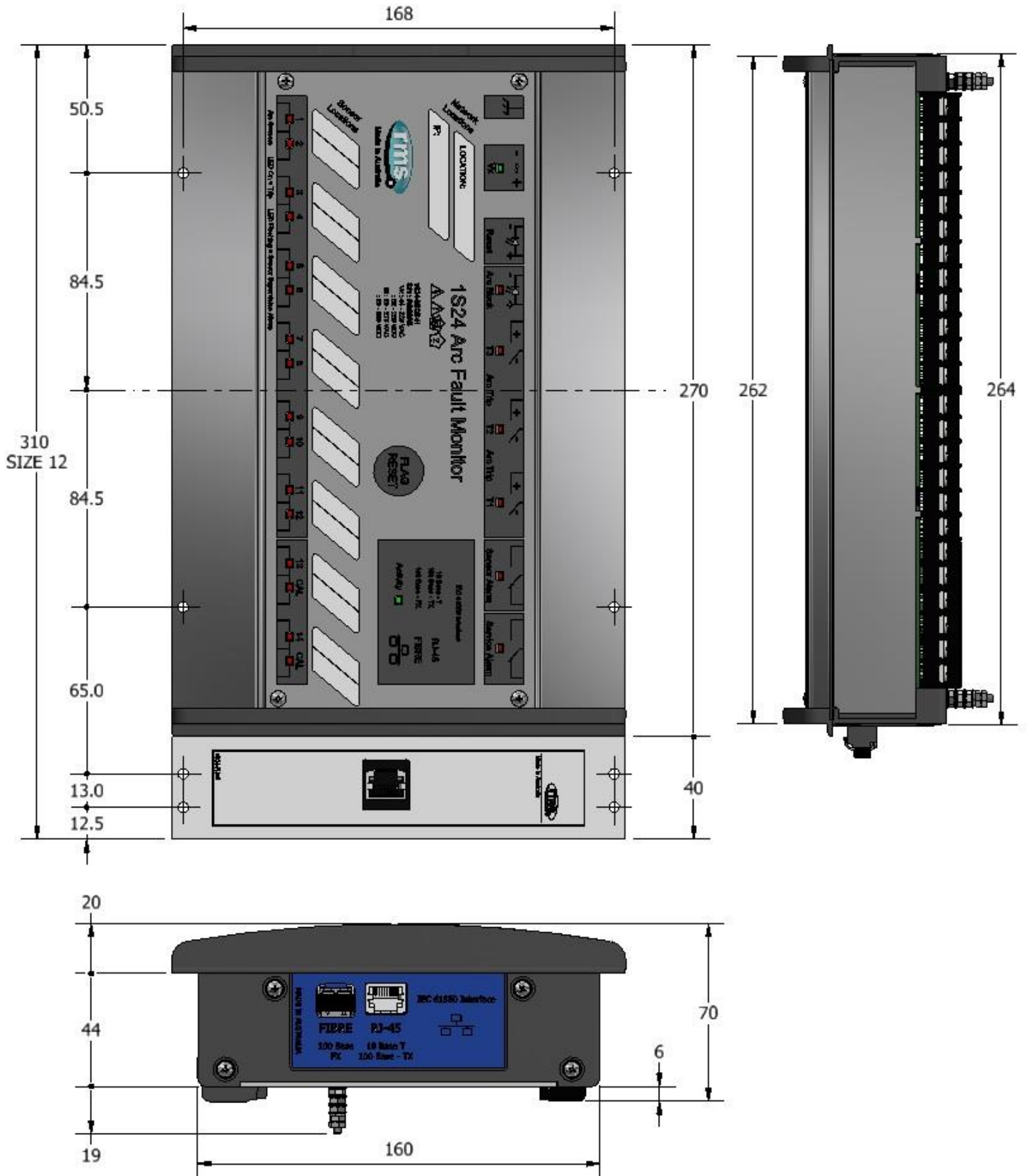

Figure 42: Flush and rack mount version dimensions

## DIN Rail Mounting Kit

The 1S24 has provision to fit two (2) DIN rail mounting kits. The 1S24 may be ordered with the DIN rail kits fitted or ordered separately for fitment by the installer as per figure 43.

2x RMS P/N: 290407157 required.

## Rack Mount Blanking Plate Kit

Rack mount versions are supplied with blanking plates to increase the 1S24 module with to standard 12 units wide as per figure 44.

- 1x Blanking plate
- 1x Blanking plate with cut-out for RJ45 socket
- 1x Right angle RJ45 plug / socket

## Accessories Supplied with Each Relay

- 4 x M4 self-threading mounting screw kit
- 1 x Product Test Manual
- 1x Blanking plate kit for rack mount versions

## 1S30 Arc Fault Point Sensors

The 1S30 sensors are ordered separately.  
Refer to the 1S30 Technical Bulletin for details.

## 1S40 Arc Fault Linear Sensors

The 1S40 sensors are ordered separately.  
Refer to the 1S40 Technical Bulletin for details.

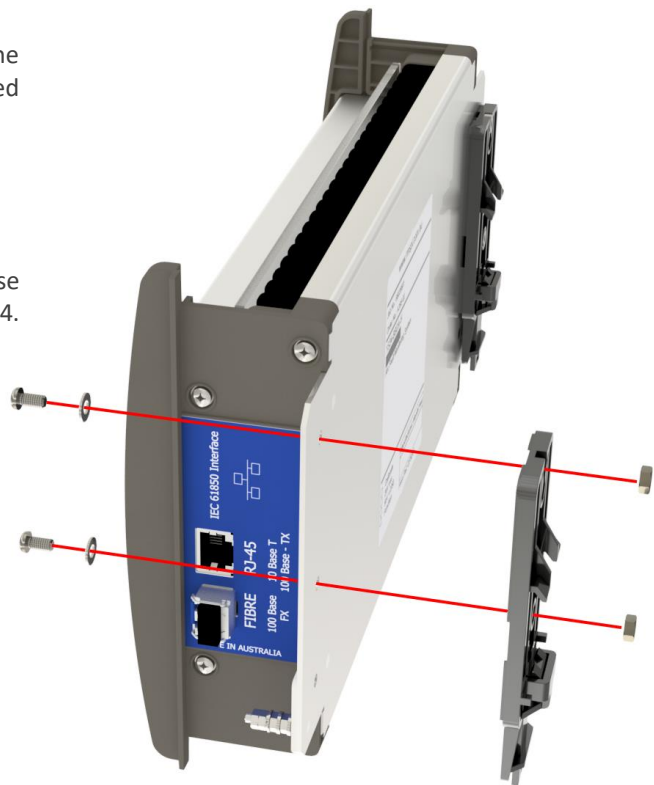

Figure 43: Fitting the DIN rail mounting kits



Figure 44: Rack mount version showing RJ45 socket fitted

# 1S24 - Order Codes

## 1S24 Relay Order Code

1S24 -			
Auxiliary Supply	A		40-58V DC
	B		44-230V AC / 62-250V DC
Ethernet Connectivity	A		Single port 10Base-T / 100Base-TX
	B		Two port 10Base-T / 100Base-TX + 100Base-FX
Arc Inputs / Trip Outputs	A		16 point sensors + 2 trip outputs
	B		12 point sensors + 2 linear sensors + 2 trip outputs
	C		16 point sensors + 3 trip outputs
	D		12 point sensors + 2 linear sensors + 3 trip outputs
Case Mounting	A		DIN rail or surface mount (DIN rail clips not included)
	B		Horizontal flush panel
	C		Vertical flush panel mount
	D		DIN rail or surface mount (2x DIN rail kits included)
	E		Rack mount (Horizontal 12U wide including plain blanking plate)
	F		Rack and flush mount (Horizontal 12U wide including RJ45 blanking plate)
	G		Vertical flush panel mount (including RJ45 blanking plate)
Future Use		-	Not used
Options		-	No options required
		H	Hybrid high speed trip outputs



---

**RMS Mors Smitt**  
19 Southern Court  
Keysborough, VIC 3173, Australia  
Tel: +61 (0)3 8544 1200  
sales.rms@wabtec.com



**Wabtec Netherlands B.V.**  
Darwinstraat 10  
6718 XR Ede, Netherlands  
Tel: +31 (0)88 600 4500  
sales.msbv@wabtec.com



Visit [www.morssmitt.com/rms](http://www.morssmitt.com/rms) for the latest product information.  
Due to RMS continuous product improvement policy this information is subject to change without notice