



1S23 User Guide

Arc Fault Monitor

RMS Mors Smitt

Advanced Protection Devices



User Guide



1S23 User Guide

About This Manual

This User Guide covers all 1S23 relays manufactured from June 2022. Earlier relays do not necessarily incorporate all the features described. Our policy of continuous development means that extra features & functionality may have been added.

The 1S23 User Guide is designed as a generic document to describe the common operating parameters for all relays built on this platform.

The copyright and other intellectual property rights in this document, and in any model or article produced from it (and including any registered or unregistered design rights) are the property of RMS Mors Smitt. No part of this document shall be reproduced or modified or stored in another form, in any data retrieval system, without the permission of RMS Mors Smitt, nor shall any model or article be reproduced from this document without consent from RMS Mors Smitt.

While the information and guidance given in this document is believed to be correct, no liability shall be accepted for any loss or damage caused by any error or omission, whether such error or omission is the result of negligence or any other cause. Any and all such liability is disclaimed.

Contact Us

RMS Mors Smitt

19 Southern Court • Keysborough 3173 • AUSTRALIA

Phone 61 3 8544 1200

Email sales.rms@wabtec.com • Web <http://www.morssmitt.com/rms>



Contents

Contents	3
Documentation	5
Technical Bulletin	5
User Guide	5
Introduction	6
1S23 Variants	6
1S23 Indications	7
Front Layout	7
Initial Power Up and Model Confirmation	7
System Healthy	8
Power Supply or CPU Fail	8
Arc Fault Pickup	8
Sensor FAIL Indications	8
Summary of Indications	9
Scheme Wiring	12
1S23 Connection diagram	12
Example Schematic	13
Over Current Relay Configuration	14
Over Current Relay Configuration	14
Application Example	14
Reyrolle Argus M Configuration	15
Input Allocation	15
Output Allocation	16
Quick Logic Equation Allocation	16
Virtual Allocation	16
LED Allocation	16
Settings Tab	17
Output Matrix	18
LED Matrix	21
1S23 Dimensions and Terminal Layout	22
Sensor Installation	23
Sensor Spacing	23
Sensor Placement	25
Sensor Mounting	25
Example Sensor Placement	26

Commissioning	30
Commissioning Preliminaries	30
Site Commissioning Verification Checklist	31
System Power Up	31
SUPERVISION Output Verification.....	32
Arc Trip Testing	33
ARC Trip Trouble Shooting.....	34
Installation	35
Handling of Electronic Equipment	35
Safety Section	36
Explanation of Symbols & Labels	36
Equipment Operating Conditions	37
Equipment Connections	37
Decommissioning & Disposal.....	38
Maintenance	39
Mechanical Inspection.....	39
Defect Report Form	40



Documentation

Technical Bulletin

The detailed technical attributes, functional description & performance specifications for the 1S23 are described in the product Technical Bulletin.

The order of precedence for product information is as follows:

- Technical Bulletin
- User Guide

User Guide

This User Guide covers all 1S23 relay versions & describes the generic features & attributes common across all versions.

Different relay versions are required to cater for varying customer requirements such as auxiliary voltage range, I/O configuration, case style, relay functionality etc.

Introduction

The 1S23 monitors either one or two 1S30 optical sensors to detect the presence of an arcing fault within Metal Clad air insulated switchgear.

The 1S23 is designed to work in conjunction with a third party protection relay to add Arc Fault coverage to a protection scheme.

Housed in a compact din rail mounted package the 1S23 provides M4 screw terminals for connection of 1S30 optical sensors and an auxiliary voltage supply.

The 1S23 provides an Arc Fault trip output and continuously supervises the optical sensor to ensure maximum availability of the Arc Fault Protection scheme.

The interface wiring to the protection relay status inputs is provided by 2m colour coded flying leads, the blue lead provides the Arc Fault Trip output, and the white lead is for the Supervision Status output.

1S23 Variants

The 1S23 is available in a wide variety of voltages with 2 different optical sensor interfaces:

1S23 - A Single 1S30 sensor input

1S23 - B Dual 1S30 sensor inputs (i.e. 2 x 1S30 sensors connected in parallel)

Note that the correct number of 1S30 sensors must be connected to match the 1S23 optical sensor interface variant to prevent a false sensor supervision alarm.

1S23 Indications

Front Layout

The picture below depicts the indications provided on the front of the module.

The Front of the module provides LED indication of Auxiliary supply and Arc Fault Pickup.

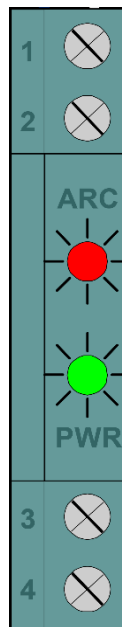

Initial Power Up and Model Confirmation

When the 1S23 is powered up both LEDs will flash a fixed number of times depending on the version of the 1S23 installed.

Power up test

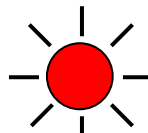

Single Sensor version : Both LEDs flash 3 times

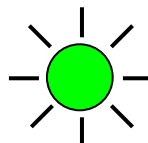

Two Sensor version : Both LEDs flash 4 times

System Healthy

The Green PWR LED illuminates solid when the module self-checking completes successfully.

System healthy  Green solid

The Supervision output will conduct to indicate System/Supervision Healthy.

Power Supply or CPU Fail

An error in the module self-checking routine will be indicated by a flashing Green PWR LED.

System Fail  Green LED Extinguished

The Supervision output will be non-conducting to indicate a module fault.

Arc Fault Pickup

Upon detection of an ARC fault the RED Arc fault pickup LED will illuminate for approximately 2 secs then reset.

Arc Fault Pickup  Red solid (for 2 seconds)

Sensor FAIL Indications

The sensor input is equipped with sensor supervision and Sensor Fail Indication. The sensor supervision checks the integrity of the wiring (for short circuit or open circuit) between the 1S30 sensor and the 1S23 monitor.

Detection of either short circuit or open circuit conditions will cause the Green PWR LED to flash.

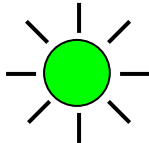













Sensor Fail  Green flashing

The Supervision output will be non-conducting to indicate sensor fail conditions.











The Sensor FAIL indications will self-reset upon the failure condition being removed.











Summary of Indications

All Indications including additional trouble shooting error indications are tabulated below :

Module Type	Red Led	Green Led	Trip Output	Supervision Output	Condition	Notes
1 or 2 Sensor Module	 Led Extinguished	 Led on solid	Non conducting	Conducting	System Healthy and no Arc Fault Pickup	
	 Led on for 2 sec	 Led on solid	Conducting for 100 msec	Conducting	Arc Fault Pickup	
	 Led Extinguished	 Led Extinguished	Non conducting	Non conducting	Power Supply Fail	
	 Led Extinguished	 Led Extinguished	Non conducting	Non conducting	Module Self Checking Failure	
	 Led on for 2 sec	 Led Extinguished for 2 sec	Non conducting for 2 sec ¹	Non conducting for 2 sec	Trip Output current limit exceeded	Scheme needs checking for correct application or a wiring fault
	 Led Extinguished	 Led repeat flash pattern (3 x 300ms illuminations and then 700ms Extinguished)	Non conducting	Non conducting	Supervision Output current limit exceeded	Scheme needs checking for correct application or a wiring fault Reset only possible by cycling power off then on
	 Led on solid	 Led repeat flash pattern (300ms illuminations)	Conducting for 100 msec and then Non conducting (further Trip outputs are inhibited)	Non conducting	Sensor continuously picked up	Reset when continuous pick up removed

¹ May exhibit transient operation prior to Trip Output current limit circuitry operating.

Module Type	Red Led	Green Led	Trip Output	Supervision Output	Condition	Notes
Single Sensor Module	 Led flashes 3 times	 Led flashes 3 times	Non conducting	Non conducting	Power Up Test for Single Sensor Module	
	 Led Extinguished	 Led repeat flash pattern (300ms illuminations)	Non conducting	Non conducting	1 Sensor connected and sensor open or short circuited	
	 Led Extinguished	 Led on solid	Non conducting	Conducting	2 Sensors connected 1 Sensor open circuited	<u>Sensor Fault condition is not indicated!</u> <u>This version of 1S23 only works correctly with one sensor connected only.</u>
	 Led Extinguished	 Led repeat flash pattern (300ms illuminations)	Non conducting	Non conducting	2 Sensors connected 1 of 2 Sensors short circuited	<u>This version of 1S23 only works correctly with one sensor connected only</u>
	 Led Extinguished	 Led repeat flash pattern (300ms illuminations)	Non conducting	Non conducting	2 Sensors connected and both Sensors open or short circuited	<u>This version of 1S23 only works correctly with one sensor connected only</u>

Module Type	Red Led	Green Led	Trip Output	Supervision Output	Condition	Notes
Two Sensor Module	 Led flashes 4 times	 Led flashes 4 times	Non conducting	Non conducting	Power Up Test for Two Sensor Module	
	 Led Extinguished	 Led repeat flash pattern (300ms illuminations)	Non conducting	Non conducting	1 Sensor connected and open circuited	<u>This version of 1S23 only works correctly with two sensors connected only.</u>
	 Led Extinguished	 Led repeat flash pattern (300ms illuminations)	Non conducting	Non conducting	2 Sensors connected and 1 or both open circuited	
	 Led Extinguished	 Led repeat flash pattern (300ms illuminations)	Non conducting	Non conducting	1 Sensor connected and short circuited	<u>This version of 1S23 only works correctly with two sensors connected only.</u>
	 Led Extinguished	 Led repeat flash pattern (300ms illuminations)	Non conducting	Non conducting	2 Sensors connected and short circuited	

Scheme Wiring

1S23 Connection diagram

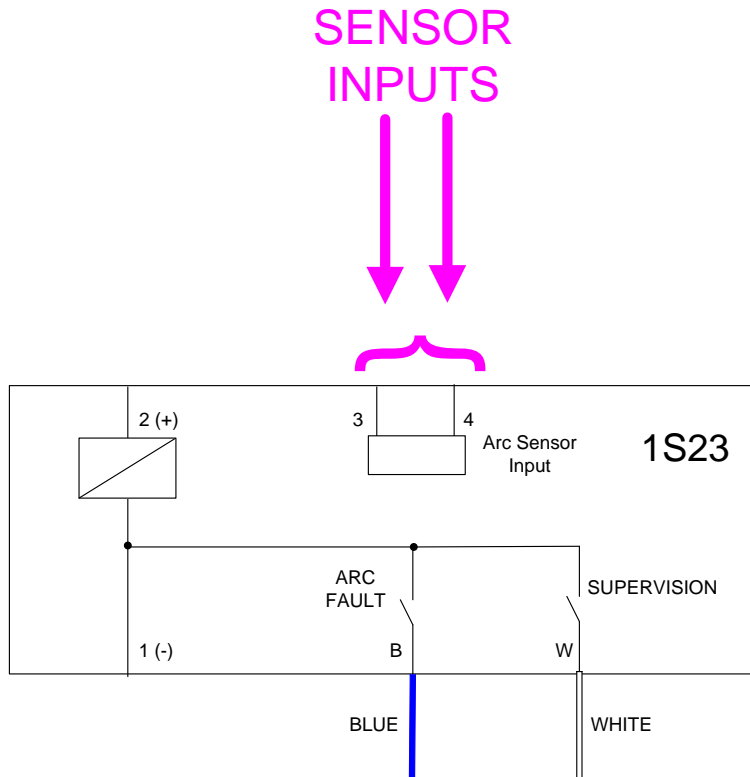

The above diagram shows the 1S23 connections including the Blue and White flying leads.

The 1S23 is ordered as either a single sensor or 2 sensor version.

Sensor connection is not polarity sensitive. On the 2 sensor version, the red wires and black wires of the ARC Fault Sensor should be paired and terminated on to the 1S23 Arc Sensor Input.

Note : The single sensor version and 2 sensor version must be used for their intended application otherwise a sensor fail condition will arise and correct ARC Trip operation cannot be guaranteed.

- A single sensor must be used with a single sensor version of the 1S23 (1S23-A#).
- 2 Sensors must be used with a 2 sensor version of the 1S23 (1S23-B#).

Note : The ARC FAULT and SUPERVISION outputs of the 1S23 employ switched negatives.

Example Schematic

The following typical schematic shows how the 1S23 is wired to interface with an Overcurrent relay for circuit breaker tripping.

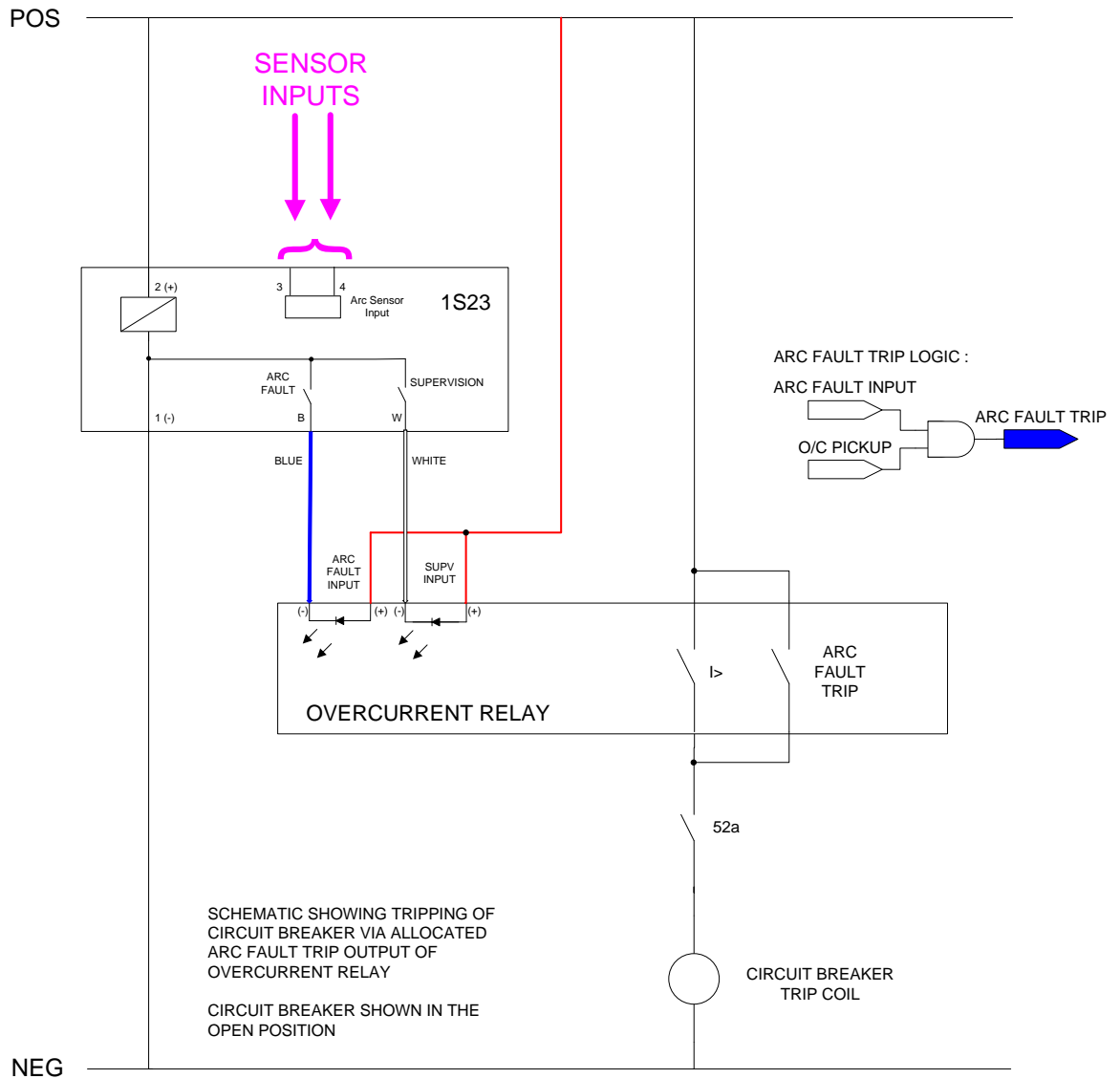

The ARC FAULT and SUPERVISION outputs of the 1S23 employ switched negatives and must be applied to isolated digital inputs.

The digital inputs interfacing with the 1S23 must not have a common negative with any other digital input.

Over Current Relay Configuration

Over Current Relay Configuration

The 1S23 ARC Module outputs are designed for connection to dedicated binary status inputs on a protection relay. The 1S23 outputs are not suitable for direct tripping applications of auxiliary relays or circuit breaker coils.

The 1S23 ARC Module does not require configuration or setting.

The following section provides an example of the Over Current Relay Configuration to accept an ARC Trip and Supervision inputs from a 1S23 Arc Fault Module.

Application Example

Arc fault protection is to be applied to a Feeder switchboard panel to provide coverage of the Current Transformer and Cable termination chambers as shown in the diagram below.

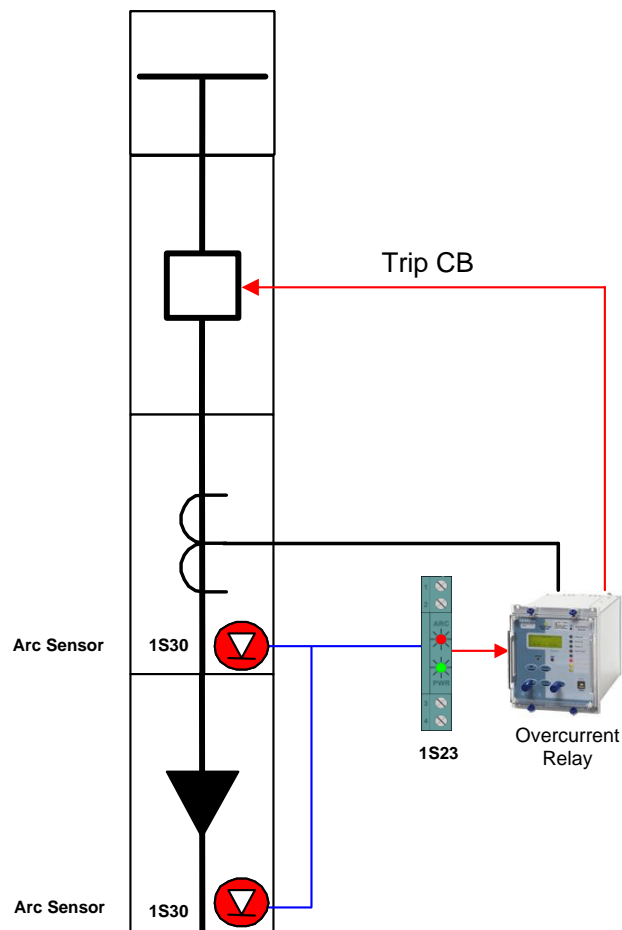

The design criteria for this application example are itemised below :

1. The Current Transformer and Cable termination chambers are to be covered in a common zone by 2 separate Arc fault sensors connected to a single 1S23 Arc Fault Module.
2. The ARC Fault Trip shall be interlocked with a fast current check element in the overcurrent relay using configurable logic within the overcurrent relay.
3. The ARC Trip output from the 1S23 shall be wired to an allocated isolated input of the Overcurrent Relay for CB Tripping and ARC Fault Trip Alarm purposes.
4. The SUPERVISION output from the 1S23 shall be wired to an allocated isolated input of the Overcurrent Relay for ARC Sensor Alarm purposes.
5. The Overcurrent Relay shall have outputs allocated for
 - a. CB Trip
 - b. ARC Fault Trip Alarm
 - c. SUPERVISION Fail Alarm (For Supervision Fail condition)

For the purposes of this example a Reyrolle Argus M relay shall be employed to demonstrate how to interface an Overcurrent relay with a 1S23 Arc Fault Module.

Equally any protection relay capable of providing a fast overcurrent protection element and configurable logic and assignable inputs may be utilised.

Reyrolle Argus M Configuration

In this application the following allocations are adopted :

Input Allocation

Input Function	Binary Input
1S23 ARC Trip	Input 1
1S23 SUPERVISION Fail	Input 2 (Input is to be Inverted to indicate Fail condition)

Output Allocation

Output Function	Binary Output
ARC Fault Trip Output	Output 2
1S23 SUPERVISION ALARM	Output 3
ARC Fault Trip Alarm	Output 4

Quick Logic Equation Allocation

Quick Logic Equation Function	Quick Logic Equation
ARC Fault Input and Current Check Interlock (ARC Fault Trip logic)	E1

Virtual Allocation

Virtual Function	Virtual
50-1 Current Check	V1

LED Allocation

LED Function	LED
ARC Fault Trip Output	L1
1S23 SUPERVISION Fail	L2
1S23 ARC Trip	L3

Using Reysdisp Evolution and the above allocation information we create a setting configuration according to the following screen shots :

Settings Tab

Here the 50-1 Phase Instantaneous Protection Element has been enabled.

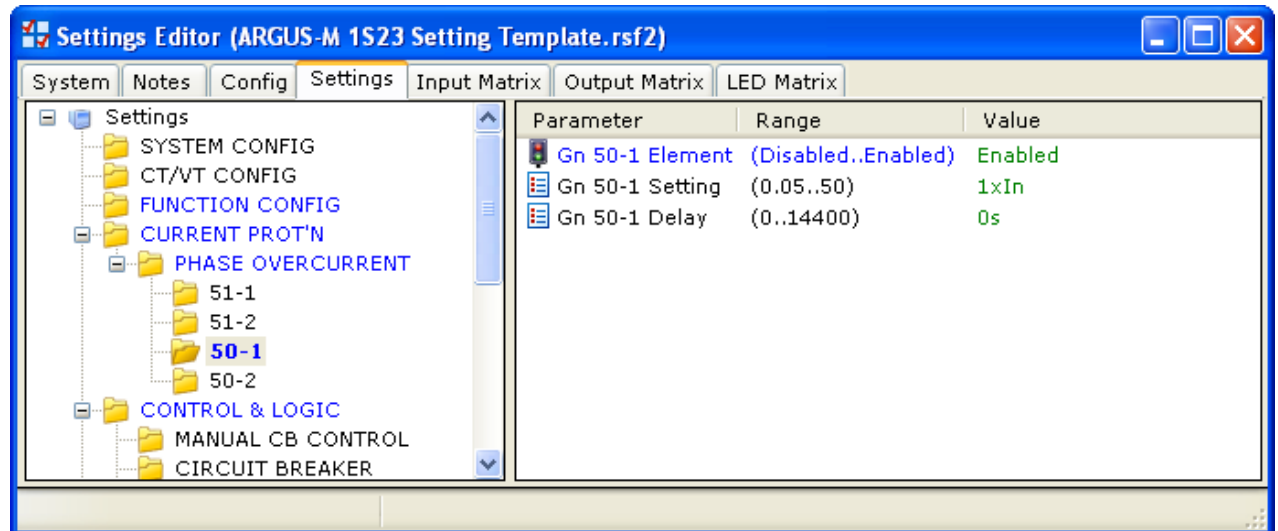

Quick Logic Equation E1 provides the Current Check interlock for the ARC Fault Input (I1.V1)

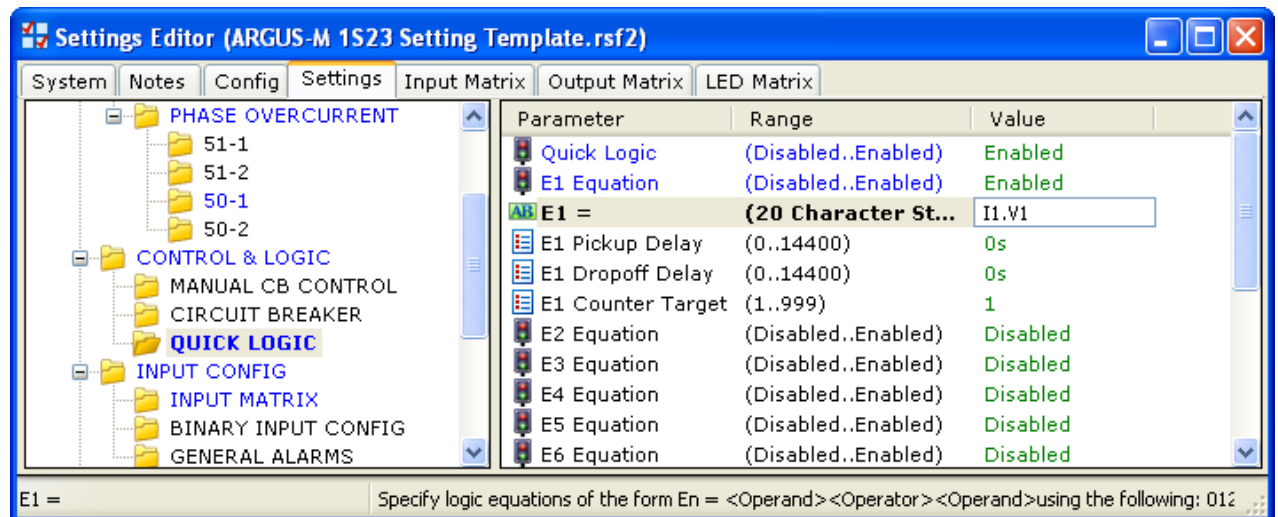

ARC FAULT TRIP LOGIC :

ARC FAULT INPUT

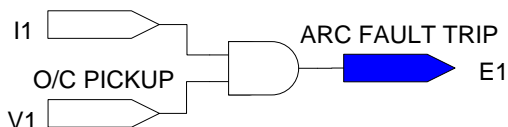

Quick Logic :

E1 = I1.V1

Output Matrix Allocations :

E1 => B02 (ARC Fault Trip)

E1 => B04 (ARC Fault Trip Alarm)

Output Matrix

The 50-1 Element is assigned to V1 for our current check logic.

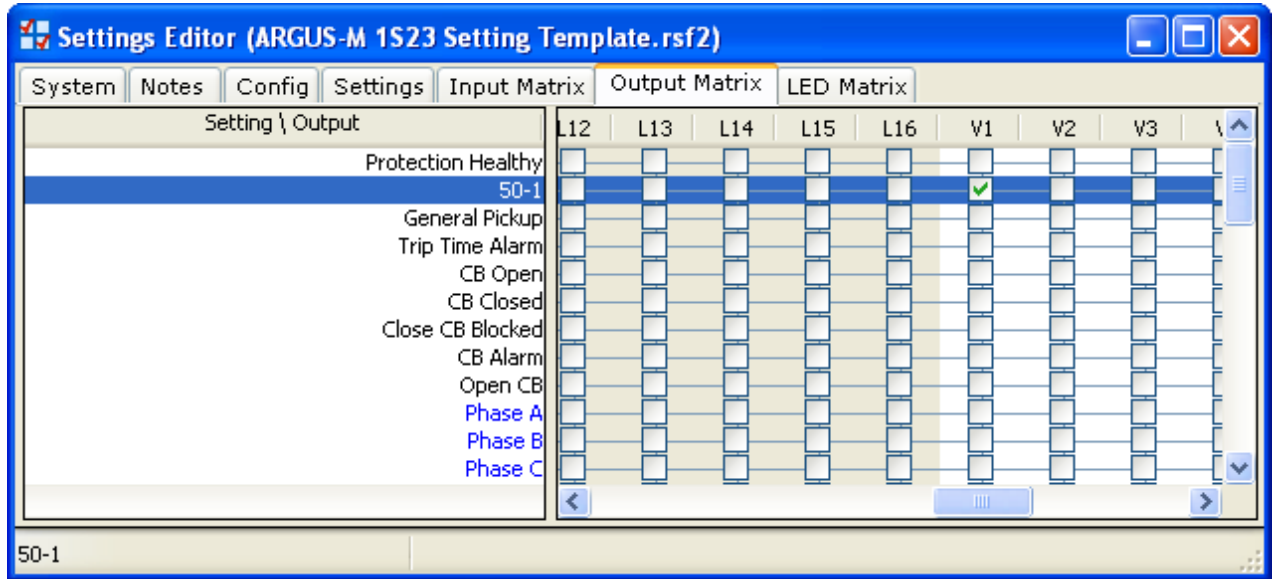

Setting \ Output	L12	L13	L14	L15	L16	V1	V2	V3
Protection Healthy	<input type="checkbox"/>	<input type="checkbox"/>	<input type="checkbox"/>	<input type="checkbox"/>	<input type="checkbox"/>	<input type="checkbox"/>	<input type="checkbox"/>	<input type="checkbox"/>
50-1	<input type="checkbox"/>	<input type="checkbox"/>	<input type="checkbox"/>	<input type="checkbox"/>	<input type="checkbox"/>	<input checked="" type="checkbox"/>	<input type="checkbox"/>	<input type="checkbox"/>
General Pickup	<input type="checkbox"/>	<input type="checkbox"/>	<input type="checkbox"/>	<input type="checkbox"/>	<input type="checkbox"/>	<input type="checkbox"/>	<input type="checkbox"/>	<input type="checkbox"/>
Trip Time Alarm	<input type="checkbox"/>	<input type="checkbox"/>	<input type="checkbox"/>	<input type="checkbox"/>	<input type="checkbox"/>	<input type="checkbox"/>	<input type="checkbox"/>	<input type="checkbox"/>
CB Open	<input type="checkbox"/>	<input type="checkbox"/>	<input type="checkbox"/>	<input type="checkbox"/>	<input type="checkbox"/>	<input type="checkbox"/>	<input type="checkbox"/>	<input type="checkbox"/>
CB Closed	<input type="checkbox"/>	<input type="checkbox"/>	<input type="checkbox"/>	<input type="checkbox"/>	<input type="checkbox"/>	<input type="checkbox"/>	<input type="checkbox"/>	<input type="checkbox"/>
Close CB Blocked	<input type="checkbox"/>	<input type="checkbox"/>	<input type="checkbox"/>	<input type="checkbox"/>	<input type="checkbox"/>	<input type="checkbox"/>	<input type="checkbox"/>	<input type="checkbox"/>
CB Alarm	<input type="checkbox"/>	<input type="checkbox"/>	<input type="checkbox"/>	<input type="checkbox"/>	<input type="checkbox"/>	<input type="checkbox"/>	<input type="checkbox"/>	<input type="checkbox"/>
Open CB	<input type="checkbox"/>	<input type="checkbox"/>	<input type="checkbox"/>	<input type="checkbox"/>	<input type="checkbox"/>	<input type="checkbox"/>	<input type="checkbox"/>	<input type="checkbox"/>
Phase A	<input type="checkbox"/>	<input type="checkbox"/>	<input type="checkbox"/>	<input type="checkbox"/>	<input type="checkbox"/>	<input type="checkbox"/>	<input type="checkbox"/>	<input type="checkbox"/>
Phase B	<input type="checkbox"/>	<input type="checkbox"/>	<input type="checkbox"/>	<input type="checkbox"/>	<input type="checkbox"/>	<input type="checkbox"/>	<input type="checkbox"/>	<input type="checkbox"/>
Phase C	<input type="checkbox"/>	<input type="checkbox"/>	<input type="checkbox"/>	<input type="checkbox"/>	<input type="checkbox"/>	<input type="checkbox"/>	<input type="checkbox"/>	<input type="checkbox"/>

The Quick Logic Equation E1 (ARC Fault Trip incorporating Current Check Interlock logic) is assigned to BO2 (CB Trip output) and BO4 (ARC Fault Trip Alarm).

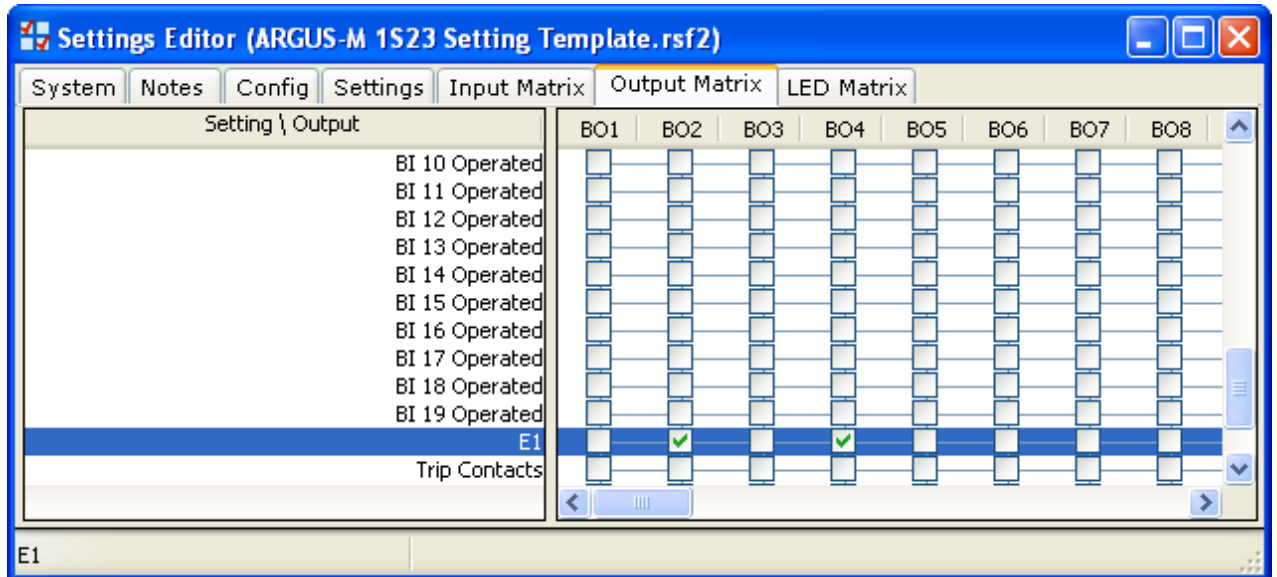

Setting \ Output	BO1	BO2	BO3	BO4	BO5	BO6	BO7	BO8
BI 10 Operated	<input type="checkbox"/>	<input type="checkbox"/>	<input type="checkbox"/>	<input type="checkbox"/>	<input type="checkbox"/>	<input type="checkbox"/>	<input type="checkbox"/>	<input type="checkbox"/>
BI 11 Operated	<input type="checkbox"/>	<input type="checkbox"/>	<input type="checkbox"/>	<input type="checkbox"/>	<input type="checkbox"/>	<input type="checkbox"/>	<input type="checkbox"/>	<input type="checkbox"/>
BI 12 Operated	<input type="checkbox"/>	<input type="checkbox"/>	<input type="checkbox"/>	<input type="checkbox"/>	<input type="checkbox"/>	<input type="checkbox"/>	<input type="checkbox"/>	<input type="checkbox"/>
BI 13 Operated	<input type="checkbox"/>	<input type="checkbox"/>	<input type="checkbox"/>	<input type="checkbox"/>	<input type="checkbox"/>	<input type="checkbox"/>	<input type="checkbox"/>	<input type="checkbox"/>
BI 14 Operated	<input type="checkbox"/>	<input type="checkbox"/>	<input type="checkbox"/>	<input type="checkbox"/>	<input type="checkbox"/>	<input type="checkbox"/>	<input type="checkbox"/>	<input type="checkbox"/>
BI 15 Operated	<input type="checkbox"/>	<input type="checkbox"/>	<input type="checkbox"/>	<input type="checkbox"/>	<input type="checkbox"/>	<input type="checkbox"/>	<input type="checkbox"/>	<input type="checkbox"/>
BI 16 Operated	<input type="checkbox"/>	<input type="checkbox"/>	<input type="checkbox"/>	<input type="checkbox"/>	<input type="checkbox"/>	<input type="checkbox"/>	<input type="checkbox"/>	<input type="checkbox"/>
BI 17 Operated	<input type="checkbox"/>	<input type="checkbox"/>	<input type="checkbox"/>	<input type="checkbox"/>	<input type="checkbox"/>	<input type="checkbox"/>	<input type="checkbox"/>	<input type="checkbox"/>
BI 18 Operated	<input type="checkbox"/>	<input type="checkbox"/>	<input type="checkbox"/>	<input type="checkbox"/>	<input type="checkbox"/>	<input type="checkbox"/>	<input type="checkbox"/>	<input type="checkbox"/>
BI 19 Operated	<input type="checkbox"/>	<input type="checkbox"/>	<input type="checkbox"/>	<input type="checkbox"/>	<input type="checkbox"/>	<input type="checkbox"/>	<input type="checkbox"/>	<input type="checkbox"/>
E1	<input type="checkbox"/>	<input checked="" type="checkbox"/>	<input type="checkbox"/>	<input checked="" type="checkbox"/>	<input type="checkbox"/>	<input type="checkbox"/>	<input type="checkbox"/>	<input type="checkbox"/>
Trip Contacts	<input type="checkbox"/>	<input type="checkbox"/>	<input type="checkbox"/>	<input type="checkbox"/>	<input type="checkbox"/>	<input type="checkbox"/>	<input type="checkbox"/>	<input type="checkbox"/>

Quick Logic Equation E1 (ARC Fault Trip incorporating Current Check Interlock logic) is also assigned to LED1 for ARC Fault Trip LED Indication purposes on the relay.

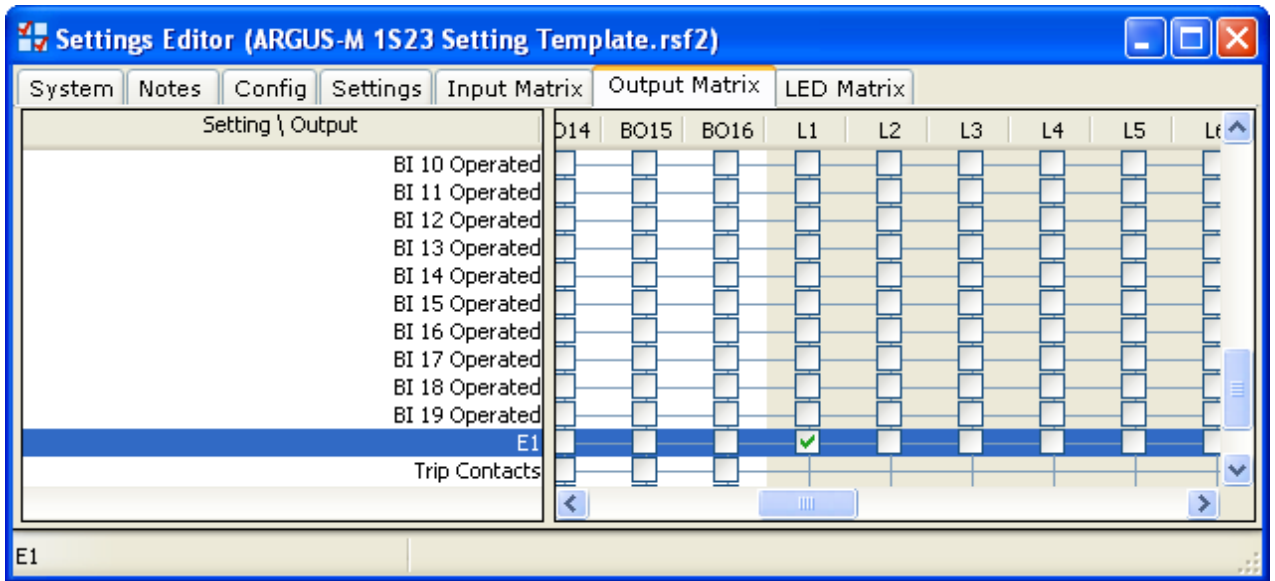

BI2 which is allocated for 1S23 SUPERVISION Fail is assigned to BO3 to provide the 1S23 SUPERVISION ALARM output.

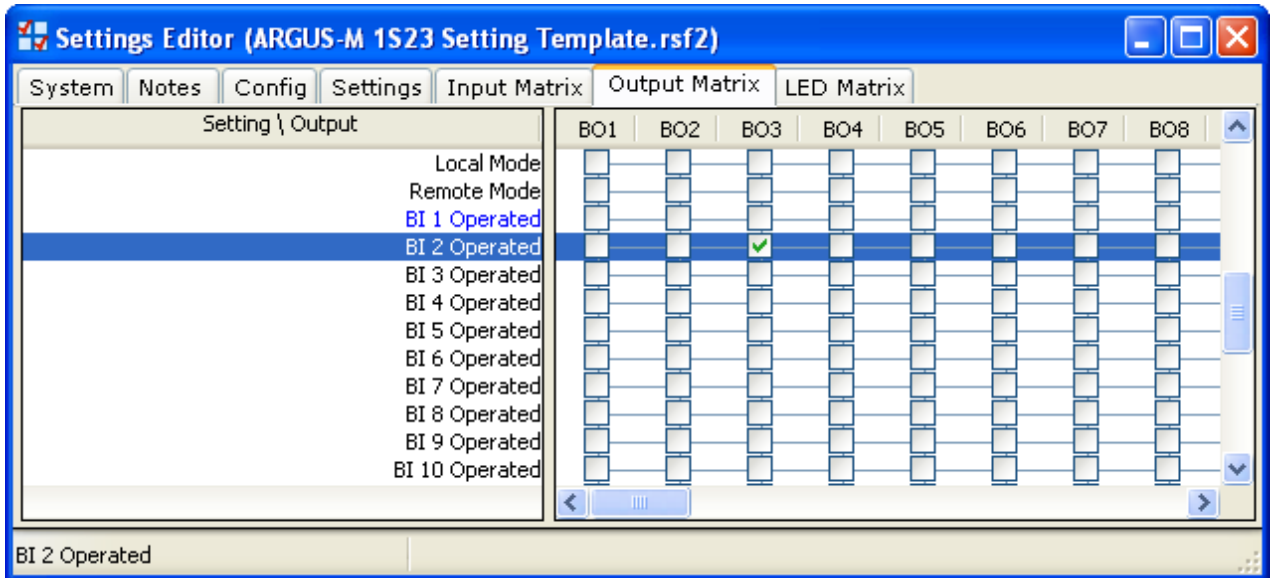

BI2 is inverted to cater for the removal of voltage to indicate the 1S23 SUPERVISION Fail condition.

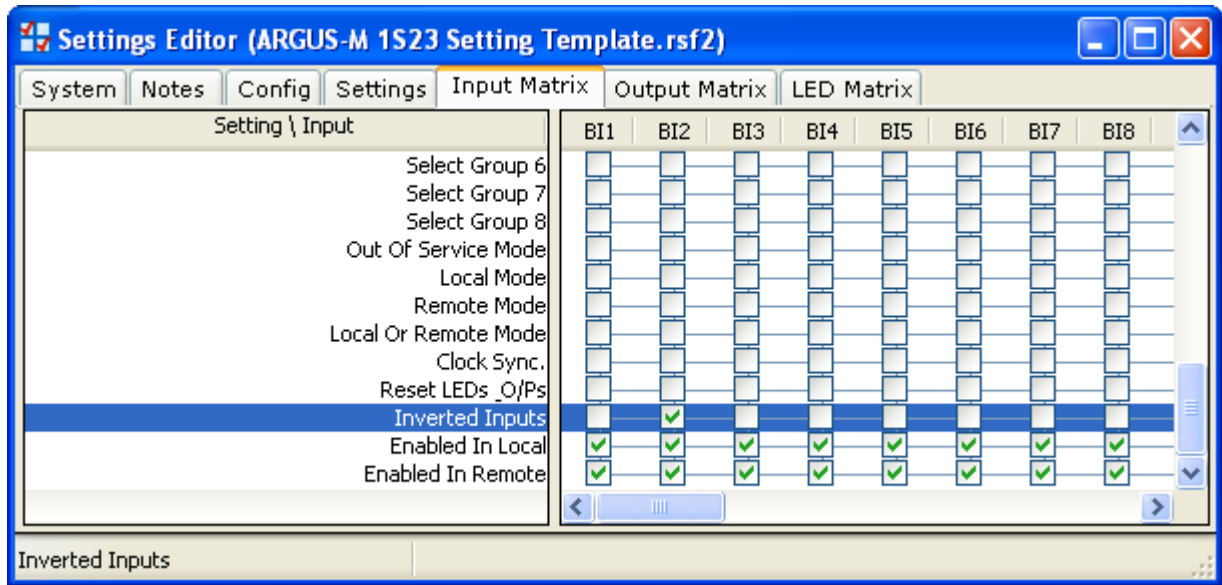

BI2 which is allocated for 1S23 SUPERVISION Fail is also assigned to LED2 for LED Indication purposes on the relay.

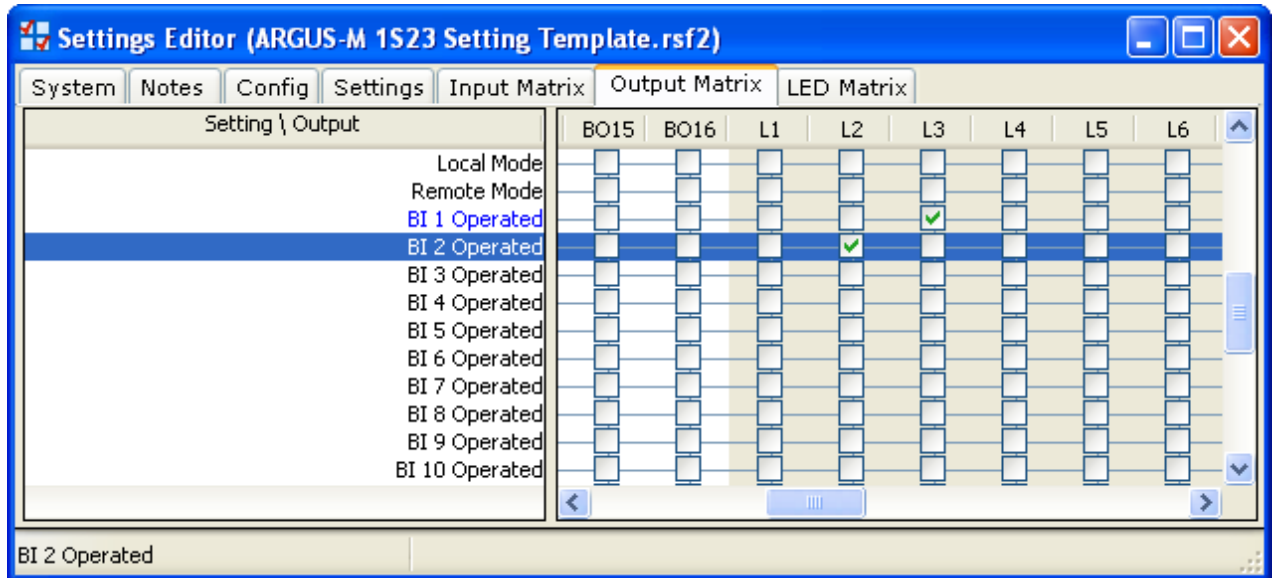

BI1 which is allocated for 1S23 ARC Trip is also assigned to LED3 for LED Indication purposes on the relay.

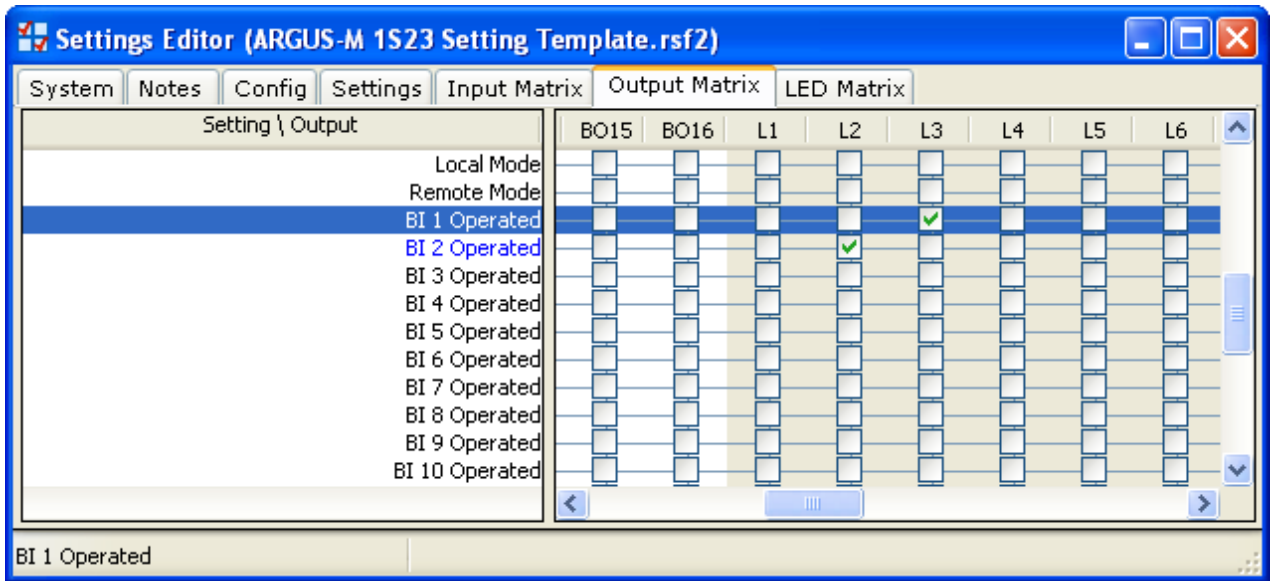

LED Matrix

The LED Matrix defines the colour and latching or self resetting behaviour of the LEDs.

LED 1 : ARC Fault Trip : Red LED and latched

LED 2 : 1S23 SUPERVISION : Orange LED and self resetting

LED 3 : 1S23 ARC Trip : Red LED and latched (Indication of 1S23 Output Operation)

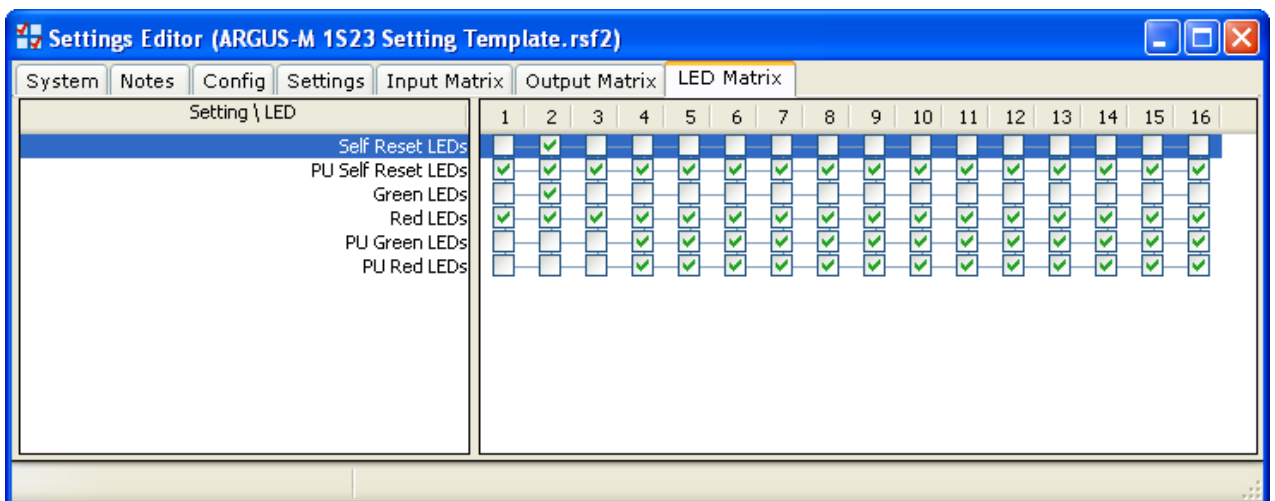

1S23 Dimensions and Terminal Layout

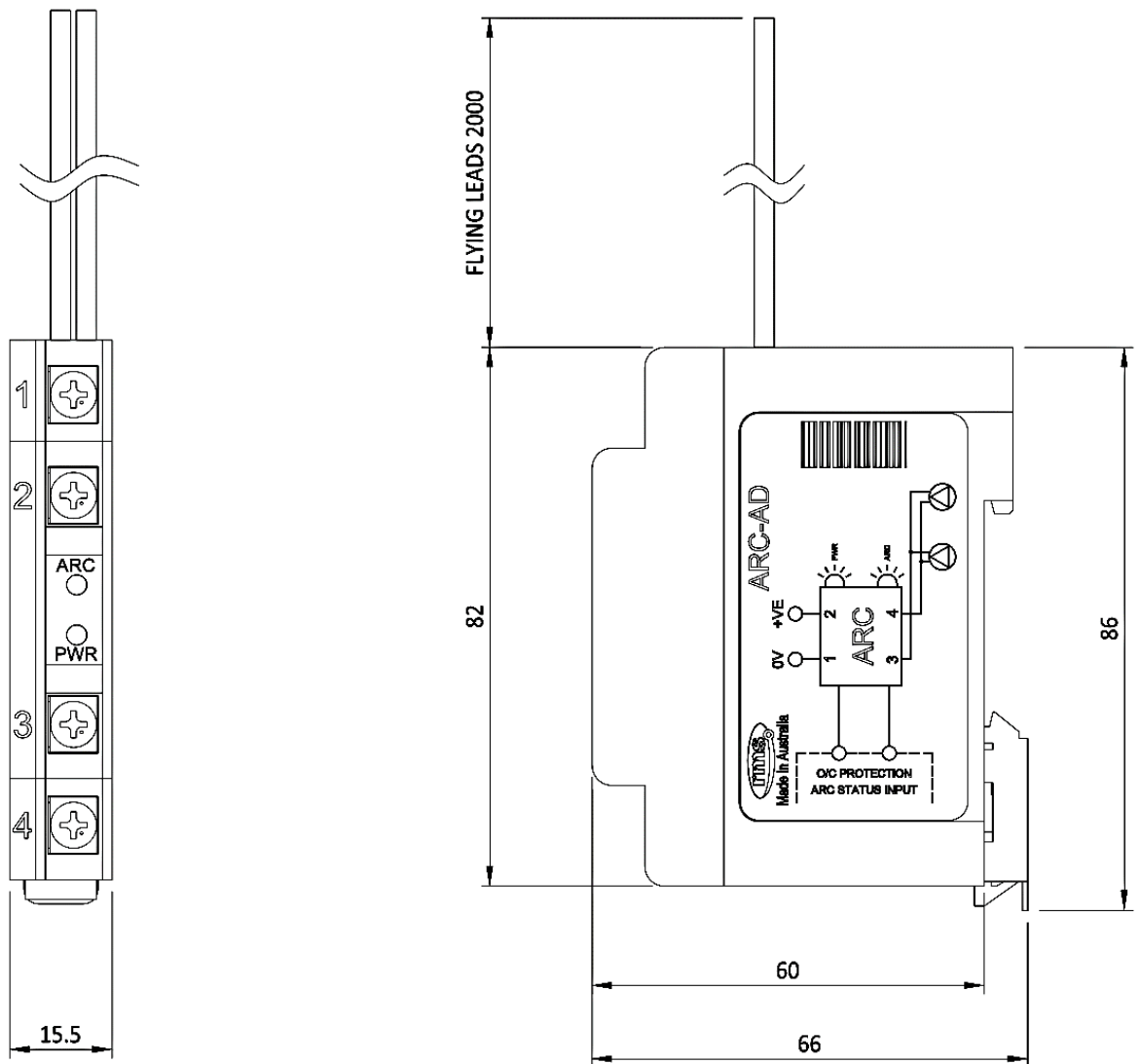

The module is designed for mounting on 35mm top hat din rail.

The flying leads comprise of 2 x 2,000mm 0.75 mm² cores.

Refer to the 1S23 Technical Bulletin for complete installation details.

Sensor Installation

Sensor Spacing

The 1S30 sensor is available as a single detector or dual detector package.

The 1S30A single detector version is depicted below showing the location of the detection window and the approximate coverage zone :

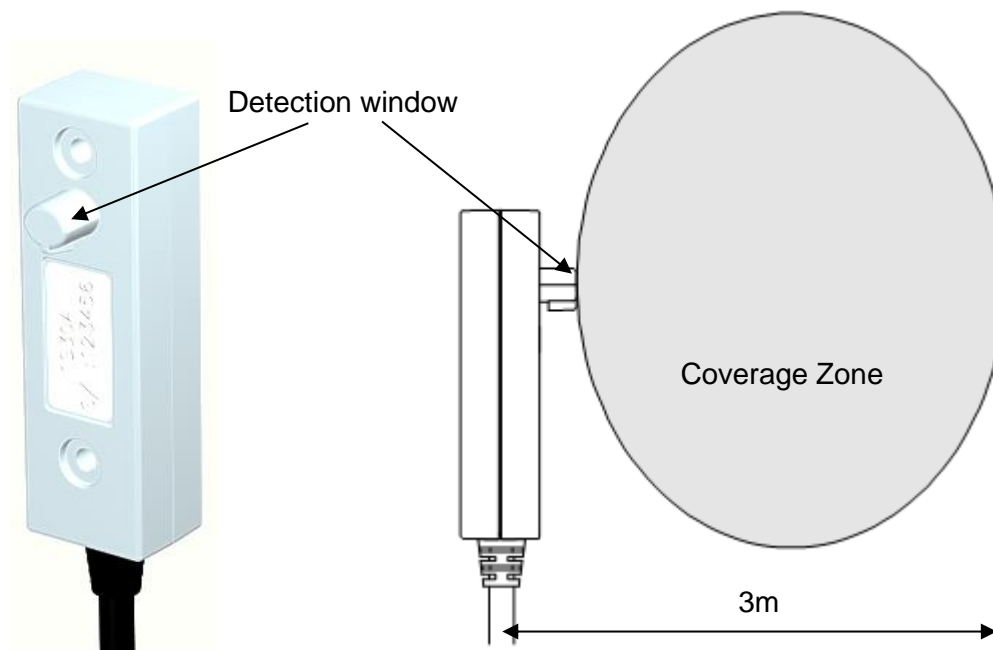

The recommended spacing for the 1S30A single detectors is approximately 5 - 6 m to ensure adequate detection overlap.

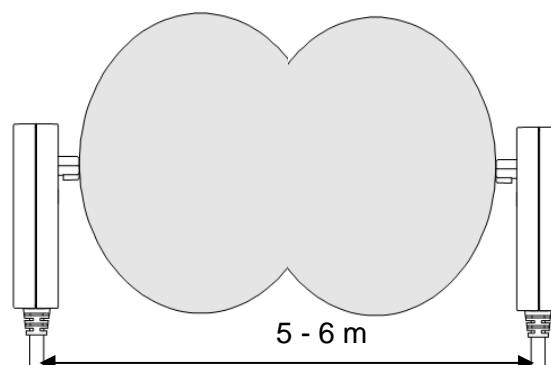

The 1S30B Dual detector version provides an additional detection window for dual zones of coverage as depicted below :

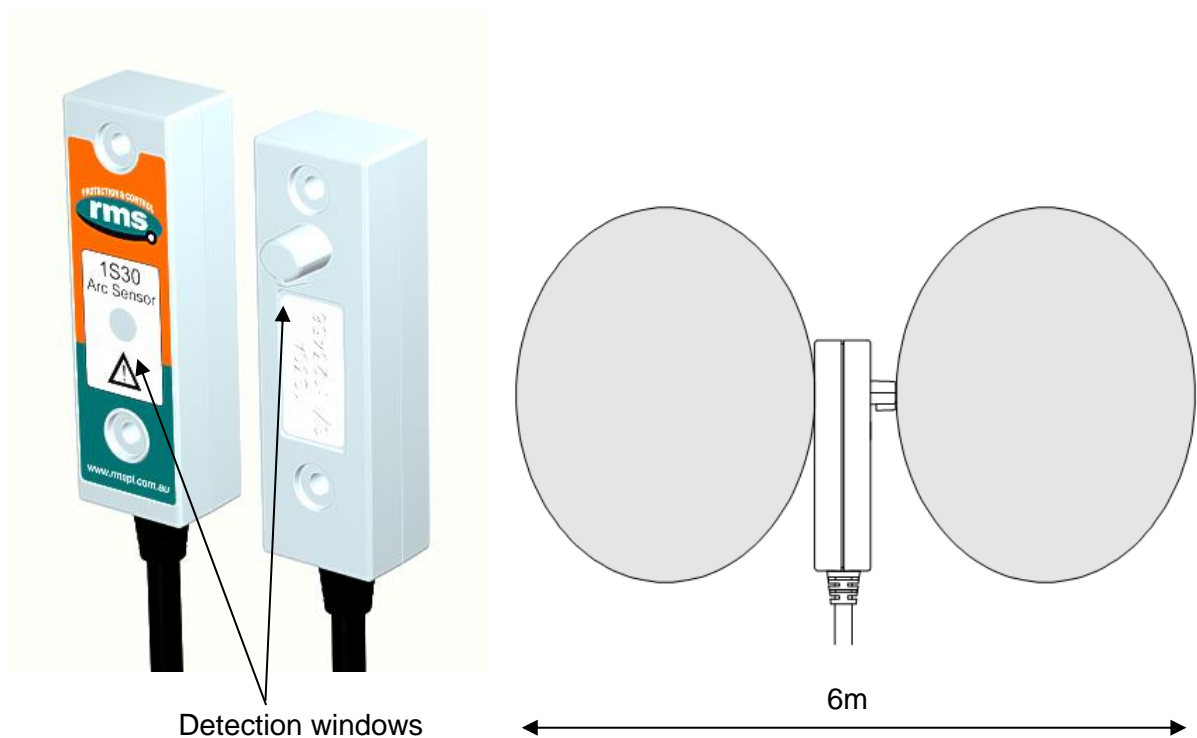

The recommended spacing for the 1S30B single detectors is approximately 5 - 6 m to ensure adequate detection overlap, this combination provides an overall coverage zone of approximately 10 - 12 m.

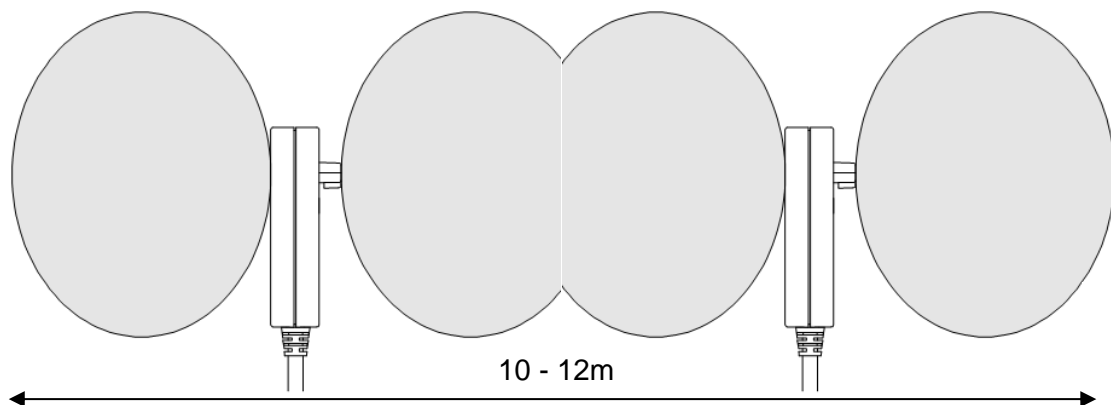

The 1S30A and 1S30B sensors may also be mixed to provide various coverage combinations, again spacings of approximately 5 - 6 m should be observed to ensure adequate detection overlap.

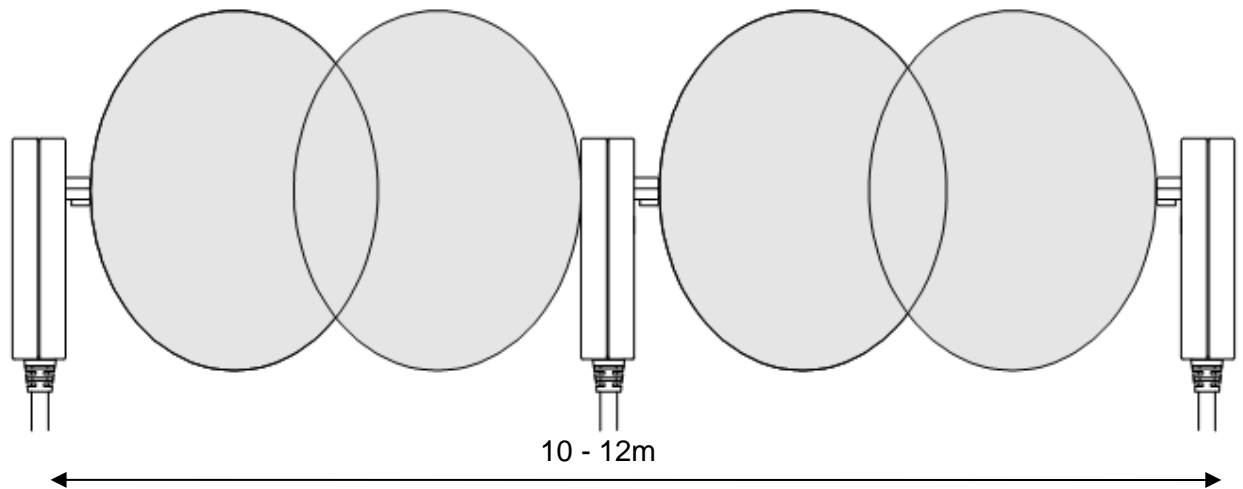

Sensor Placement

Sensors need to be mounted to provide full coverage of the switchgear cubicles to be protected. Where the protected zone is larger than the sensor coverage then the use of multiple sensors is required.

Precise positioning of the sensors is generally not required as the light caused by the arc is reflected from the switchgear walls.

Sensor Mounting

The 1S30 is suitable for flush panel mounting in a number of configurations, for further information on mounting arrangements and mounting hardware refer to the 1S30 Technical Bulletin.

Example Sensor Placement

The following are some typical examples of sensor placement.



Sensor placement inside the CB racking chamber



Sensor placement inside the busbar chamber



Sensor placement inside the cable termination chamber



Sensor placement for switchgear Busbar coverage (External through Hole Detector)



Sensor placement near a Low Voltage Contactor for a Variable Speed Drive



Sensor placement for a Switchgear cable termination chamber (External through Hole Detector)

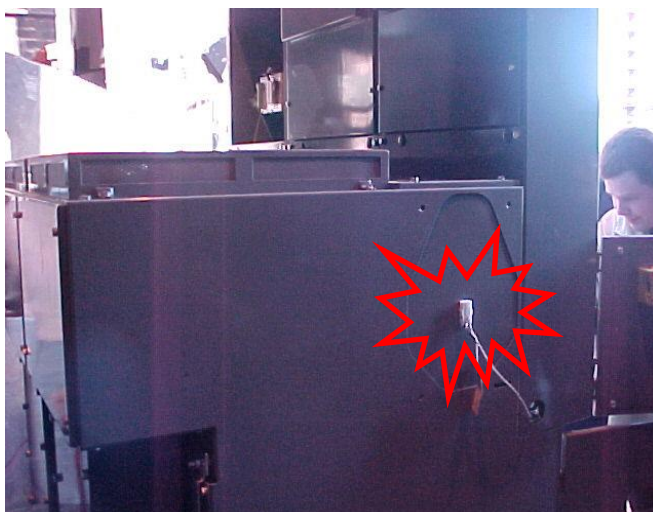

Sensor placement for an end of Bus chamber (External through Hole Detector)



Sensor placement for a Switchgear cable termination chamber (External through Hole Detector)

Commissioning

Commissioning Preliminaries

Carefully examine the module to ensure that no damage has occurred during transit. Check that the model number and rating information are correct.

Insulation

The relay, and its associated wiring, may be insulation tested between:

- all electrically isolated circuits
- all circuits and earth

An electronic or brushless insulation tester should be used, having a dc voltage not exceeding 1000V. Accessible terminals of the same circuit should first be strapped together. Deliberate circuit earthing links, removed for the tests, subsequently must be replaced.

ARC Trip Verification

ARC Trip Verification will require a flash source to initiate sensor operation.

A high powered photographic flash is the most convenient means of initiating a positive sensor operation.

Note that mobile phone or small compact camera flashes may not have sufficient power to cause sensor operation.

The RMS '1S23 Arc Flash Timing Test Guide' outlines a suggested test setup to provide a flash source and determine ARC Trip times. The '1S23 Arc Flash Timing Test Guide' is available on the Mors Smitt website :

<https://www.morssmitt.com/uploads/files/catalog/products/1s23-arc-flash-timing-test-guide.pdf>

Site Commissioning Verification Checklist

Observe all site specific standard safety procedures.

The following tests are undertaken following the completion of all 1S23 ARC Module and Overcurrent Relay scheme wiring and the wiring of all 1S30 sensors.

System Power Up

Item	Description	Complete
1	Confirm all necessary primary equipment isolations	
2	Confirm all necessary secondary equipment isolations (including trip outputs)	
3	Check fitment of 1S30 optical sensors and cable condition	
4	Check panel installation of the 1S23 ARC Module	
5	Check the 1S23 is wired to the protection design schematic	
6	Confirm 1S23 SUPERVISION output is non conducting by confirming that the associated Overcurrent relay 1S23 SUPERVISION input becomes de-asserted (alternatively using a voltmeter check the voltage across the White Supervision Flying lead and Terminal 1 of the 1S23 is \approx +Pos supply voltage)	
7	Confirm that the correct number of sensors are connected to the module according to the order code.	
8	Apply correct Auxiliary voltage to power up the 1S23 Observe the LED indication upon power up and confirm the module version corresponds to the module order code : Single Sensor version : Red and Green LED flash 3 times Two Sensor version : Red and Green LED flash 4 times The Green PWR LED will then illuminate solid green to indicate System Healthy	
9	Confirm 1S23 SUPERVISION output is conducting by confirming that the associated Overcurrent relay 1S23 SUPERVISION input becomes asserted (alternatively using a voltmeter check the voltage across the White Supervision Flying lead and Terminal 1 of the 1S23 is \approx 0V (< 0.5V)	
10	Confirm that the Green PWR LED indicates no sensor fail conditions (Refer Sensor Failure Trouble shooting if sensor failure is indicated)	
11	Confirm that no ARC fault trips are indicated	

SUPERVISION Output Verification

Item	Description	Complete
1	In turn disconnect each sensor from the associated 1S23 sensor input	
2	Confirm that the Green PWR LED flashes and the SUPERVISION output becomes non conducting by confirming that the associated Overcurrent relay 1S23 SUPERVISION input becomes de-asserted (alternatively using a voltmeter check the voltage across the White Supervision Flying lead and Terminal 1 of the 1S23 is \approx +Pos supply voltage)	
3	Reconnect all sensors back to the associated 1S23 sensor input	
4	Confirm that the Green PWR LED returns to solid illumination and the 1S23 SUPERVISION output is conducting by confirming that the associated Overcurrent relay 1S23 SUPERVISION input becomes asserted (alternatively using a voltmeter check the voltage across the White Supervision Flying lead and Terminal 1 of the 1S23 is \approx 0V (< 0.5V)	
5	Place a short across the 1S23 sensor input	
6	Confirm that the Green PWR LED flashes and the 1S23 SUPERVISION output becomes non conducting by confirming that the associated Overcurrent relay 1S23 SUPERVISION input becomes de-asserted (alternatively using a voltmeter check the voltage across the White Supervision Flying lead and Terminal 1 of the 1S23 is \approx +Pos supply voltage)	
7	Remove the short from the 1S23 sensor input	
8	Confirm that the Green PWR LED returns to solid illumination and the 1S23 SUPERVISION output is conducting by confirming that the associated Overcurrent relay 1S23 SUPERVISION input becomes asserted (alternatively using a voltmeter check the voltage across the White Supervision Flying lead and Terminal 1 of the 1S23 is \approx 0V (< 0.5V)	

Arc Trip Testing

Item	Description	Complete
1	Initiate the operation of each sensor by the use of a suitably powered camera flash * If a current check interlock is employed in your ARC Fault protection scheme ensure that current is injected into the associated Overcurrent relay to cause operation of the current check element at the same time the sensor is flashed	
2	Check for correct operation of the RED 1S23 ARC fault output LED (2 sec illumination and then self reset)	
3	Confirm operation of the 1S23 ARC fault output is conducting by confirming that the associated Overcurrent relay 1S23 Arc Fault input becomes asserted and then drops out following the 1S23 Arc Fault Output dwell time of approx 100 ms (monitor the operation of the 1S23 output using a Relay test system such as a Doble to monitor that the voltage across the Blue ARC Fault Flying lead and Terminal 1 of the 1S23)	
4	Confirm operation of the Overcurrent relay ARC Fault Trip Output (For CB tripping)	

Refer also to the RMS '1S23 Arc Flash Timing Test Guide' for a suggested test setup to provide a flash source and determine ARC Trip times. The '1S23 Arc Flash Timing Test Guide' is available on the Mors Smitt website :

<https://www.morssmitt.com/uploads/files/catalog/products/1s23-arc-flash-timing-test-guide.pdf>

ARC Sensor Supervision Trouble Shooting

Item	Description	Complete
1	If there is a SUPERVISION indication re-check the 1S30 wiring integrity	
2	Check that the correct number of sensors are wired to the arc sensor inputs according to the ARC Module order code	
3	Check for high ambient lighting conditions for all the sensors	

Make use of the summary of indications to aid in troubleshooting.

ARC Trip Trouble Shooting

If an arc trip occurs without an ARC being present this indicates either:

- a very high ambient light condition is triggering a sensor

or

- short circuit wiring of a 1S30 sensor

In both cases if the condition persists the Supervision output will operate after a 0.5 sec delay.

Item	Description	Complete
1	Check the 1S30 wiring integrity of the sensors	
2	Check for high ambient lighting conditions for all the sensors	

Make use of the summary of indications to aid in troubleshooting.

Installation

Handling of Electronic Equipment

A person's normal movements can easily generate electrostatic potentials of several thousand volts. Discharge of these voltages into semiconductor devices when handling electronic circuits can cause serious damage, which often may not be immediately apparent, but the reliability of the circuit will have been reduced.

The electronic circuits of Relay Monitoring Systems Pty Ltd products are immune to the relevant levels of electrostatic discharge when housed in the case. Do not expose them to the risk of damage by withdrawing modules unnecessarily.

Each module incorporates the highest practicable protection for its semiconductor devices. However, if it becomes necessary to withdraw a module, the following precautions should be taken to preserve the high reliability and long life for which the equipment has been designed and manufactured.

1. Before removing a module, ensure that you are at the same electrostatic potential as the equipment by touching the case.
2. Handle the module by its front-plate, frame, or edges of the printed circuit board.
3. Avoid touching the electronic components, printed circuit track or connectors.
4. Do not pass the module to any person without first ensuring that you are both at the same electrostatic potential. Shaking hands achieves equipotential.
5. Place the module on an antistatic surface, or on a conducting surface which is at the same potential as you.
6. Store or transport the module in a conductive bag.

If you are making measurements on the internal electronic circuitry of equipment in service, it is preferable that you are earthed to the case with a conductive wrist strap.

Wrist straps should have a resistance to ground between 500k – 10M ohms. If a wrist strap is not available, you should maintain regular contact with the case to prevent the build-up of static.

Instrumentation which may be used for making measurements should be earthed to the case whenever possible.

Safety Section

This Safety Section should be read before commencing any work on the equipment.

The information in the Safety Section of the product documentation is intended to ensure that products are properly installed and handled in order to maintain them in a safe condition. It is assumed that everyone who will be associated with the equipment will be familiar with the contents of the Safety Section.

Explanation of Symbols & Labels

The meaning of symbols and labels which may be used on the equipment or in the product documentation is given below.

Caution: refer to product information



Caution: risk of electric shock

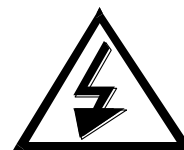

Functional earth terminal

Note: this symbol may also be used for a Protective/safety earth terminal if that terminal is part of a terminal block or sub-assembly e.g. power supply.

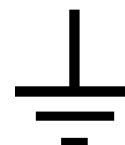

Equipment Operating Conditions

The equipment should be operated within the specified electrical and environmental limits.

Protective relays, although generally of robust construction, require careful treatment prior to installation and a wise selection of site. By observing a few simple rules, the possibility of premature failure is eliminated, and a high degree of performance can be expected.

Care must be taken when unpacking and installing the relays so that none of the parts are damaged or their settings altered and must always be handled by skilled persons only.

Relays should be examined for any wedges, clamps, or rubber bands necessary to secure moving parts to prevent damage during transit and these should be removed after installation and before commissioning.

The relay should be mounted on the circuit breaker or panel to allow the operator the best access to the relay functions.

Equipment Connections

Personnel undertaking installation, commissioning or servicing work on this equipment should be aware of the correct working procedures to ensure safety. The product documentation should be consulted before installing, commissioning or servicing the equipment.

Terminals exposed during installation, commissioning and maintenance may present hazardous voltage unless the equipment is electrically isolated.

If there is unlocked access to the rear of the equipment, care should be taken by all personnel to avoid electric shock or energy hazards.

Voltage and current connections should be made using insulated crimp terminations to ensure that terminal block insulation requirements are maintained for safety. To ensure that wires are correctly terminated, the correct crimp terminal and tool for the wire size should be used.

Before energising the equipment, it must be earthed using the protective earth terminal, or the appropriate termination of the supply plug in the case of plug connected equipment. Omitting or disconnecting the equipment earth may cause a safety hazard.

The recommended minimum earth wire size is 2.5mm², unless otherwise stated in the technical data section of the product documentation.

Before energising the equipment, the following should be checked:

1. Voltage rating and polarity;
2. CT circuit rating and integrity of connections;
3. Protective fuse rating;
4. Integrity of earth connection (where applicable)

Decommissioning & Disposal

Decommissioning: The auxiliary supply circuit in the relay may include capacitors across the supply or to earth. To avoid electric shock or energy hazards, after completely isolating the supplies to the relay (both poles of any dc supply), the capacitors should be safely discharged via the external terminals prior to decommissioning.

Disposal: It is recommended that incineration and disposal to water courses is avoided. The product should be disposed of in a safe manner.

Maintenance

Mechanical Inspection

Relay Assembly

Inspect the relay for obvious signs of damage or ingress of moisture or other contamination.

Relay Module

Isolate the relay, remove any securing screws where fitted and unplug the relay from the terminal base.

Inspect the relay for signs of any overheating or burn marks which may have been caused by overvoltage surge or transient conditions on the power supply.

Test Intervals

The maintenance tests required will largely depend upon experience and site conditions, but as a general rule it is recommended that the following inspection and tests are performed every twelve months.

- ◆ Mechanical Inspection
- ◆ Check of Connections
- ◆ Insulation Resistance Test

Defect Report Form

Please copy this sheet and use it to report any defect which may occur.

Customers Name & Address:	Contact Name:
	Telephone No:
	Fax No:
Supplied by:	Date when installed:
Site:	Circuit:

When Defect Found

Date:	Commissioning?	Maintenance?	Systems Fault?	Other, Please State:
Product Part No:			Serial Number:	
Copy any message displayed by the relay:				
Describe Defect:				
Describe any other action taken:				
Signature:		Please Print Name:		Date:

For RMS use only

Date Received:	Contact Name:	Reference No:	Date Acknowledged:	Date of Reply:	Date Cleared:
----------------	---------------	---------------	--------------------	----------------	---------------

