

CU/CP-U300-U relay - Miniature, AC coil

Datasheet

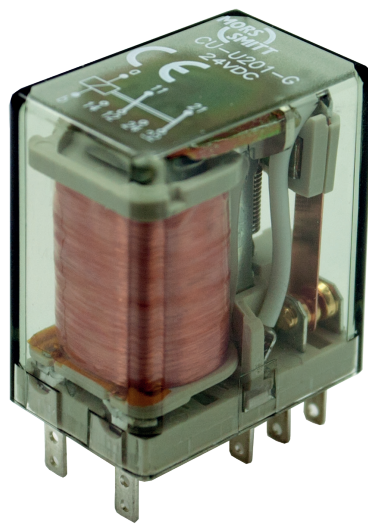

(Picture CU-U200-G is shown)

Description

Miniature railway relay with one double make, double break contact suitable for AC coil voltages with a frequency of 50/60 Hz. High maximum contact current and long electrical life.

Relay for plug-in mounting (CU version) or for PCB mounting (CP version).

Optional built-in LED (red or green colour) to indicate presence of power supply and energizing of the coil. (only CU)

The construction of the relay and choice of materials makes the CU/CP-U300-U relay suitable to withstand corrosive atmospheres, low and high temperatures, shock & vibrating and dry to very humid environments.

With a very compact design and a wide range of sockets, the CU/CP-U300-U relay is an easy and flexible solution to use.

Application

These relay series are designed for rolling stock applications where available space is limited and a high contact current is used or long electrical life is required.

Features

- Miniature plug-in / PCB relay
- AC coil
- 1 double make/double break contact
- High maximum current
- Long electrical life
- Optional built-in LED (red or green colour)
- Flat, square and tin plated relay pins for excellent socket connection / PCB mounting pins
- Wide range sockets
- Transparent cover
- Optional positive mechanical keying relay to socket

Benefits

- Proven reliable
- Long term availability
- Easy to maintain
- Used in safety critical applications
- Low life cycle cost
- No maintenance

Railway compliancy

- EN 50155 Electronic equipment used on rolling stock for railway applications
- IEC 60571 Electronic equipment used on railway vehicles
- IEC 60077 Electrical equipment for rolling stock in railway applications
- IEC 60947 Low voltage switch gear and control gear
- IEC 61373 Rolling stock equipment - Shock and vibration test
- EN 50121 Electromagnetic compatibility for railway applications
- NF F 16-101/102, EN 45545-2 Fire behaviour - Railway rolling stock
- IEC 60529 European standard describes the protection class (IP-code)
- NF F 62-002 On-off contact relays and fixed connections



CU/CP-U300-U

Technical specifications

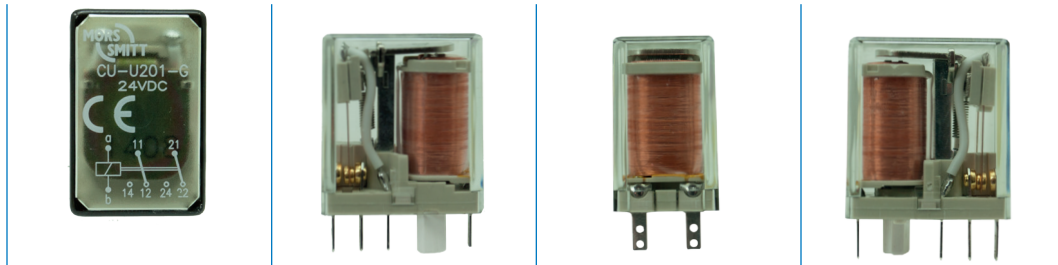

(Picture CU-U200-G is shown)

Functional and connection diagrams

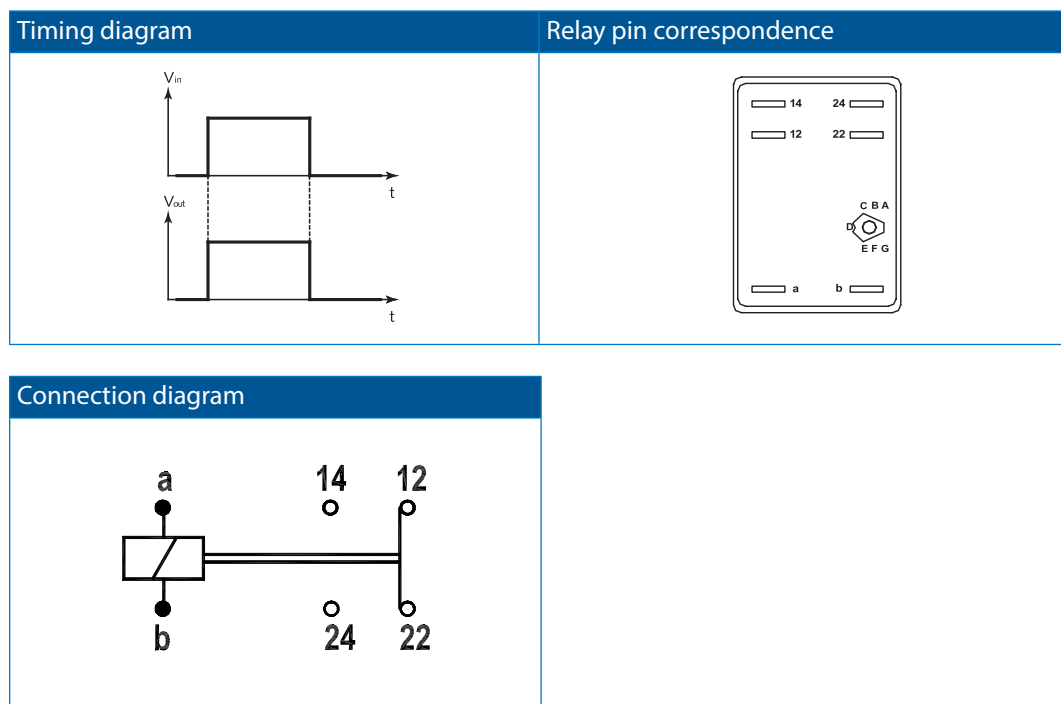

CU/CP-U300-U

Technical specifications

Coil characteristics

| | |
|---|---------------------------------|
| Operating times at nominal voltage (typical value): | |
| Pull-in time | 50 Hz ≤ 7.5 ms 60 Hz ≤ 10 ms |
| Release time | ≤ 8 ms |
| Bounce time N/O contacts | ≤ 1 ms |
| Bounce time N/C contacts | ≤ 1 ms |
| Cos φ at U _{nom} | 0.6 ms |
| Nominal power consumption | 50 Hz 0.6 VA 60 Hz 0.4 VA |
| Operating voltage range | 70 %...125 % U _{nom} |

| Type | U _{nom} (VAC) | U _{min} (VAC) | U _{max} (VAC) | U _{drop-out} (VDC) | R _{coil} (Ω)* |
|--------|------------------------|------------------------|------------------------|-----------------------------|------------------------|
| U301-U | 24 | 16.8 | 30 | 2.4 | 221 |
| U310-U | 220 | 154 | 275 | 22.0 | 15371 |
| U311-U | 115 | 80.5 | 144 | 11.5 | 2500 |

Other types on request

* The R_{coil} is measured at room temperature and has a tolerance of ± 10%

Remarks:

- U_{min} is the must-operate voltage at which the relay has picked up in all circumstances (worst-case situation), in practice the relay picks up at a lower voltage
- U_{drop-out} is the must-release voltage at which the relay has dropped-out in all circumstances (worst-case situation), in practice the relay drops out at a higher voltage

Contact characteristics

| | |
|-----------------------------|---|
| Amount and type of contacts | 1 double make / double break |
| Maximum make current | 15 A |
| Maximum continuous current | 8 A (AC1 ; IEC 60947) |
| Maximum switching voltage | 300 VDC (then max. current = 300 mA) 250 VAC (then max. current = 2.6 A) |
| Minimum switching voltage | 12 V |
| Minimum switching current | 10 mA |
| Maximum contact resistance | 15 mΩ |
| Maximum switching capacity | See graph page 5 |
| Material | Ag + 0.2 μm Au (gold flash is only for storage purpose) |
| Contact gap | 2x 0.3 mm |
| Contact force | > 20 cN |



CU/CP-U300-U

Technical specifications

Electrical characteristics

| | |
|----------------------------------|--|
| Dielectric strength | EN 50155 |
| Cont-Coil | IEC 60077 3.5 kV, 50 Hz |
| Insulation between open contacts | 2.0 kV ; 50 Hz ; 1 min |
| Pulse Withstanding | IEC 60255-5 5 kV (1.2/50 μ s) |

Mechanical characteristics

| | |
|-----------------------------|--|
| Mechanical life | 10 x 10 ⁶ operations |
| Maximum switching frequency | Mechanical: 3600 ops/h Electrical: 1200 ops/h |
| Weight | 40 g |

Environmental characteristics

| | |
|-----------------------|---|
| Environmental | EN 50125-1 and IEC 60077-1 |
| Vibration | IEC 61373, Category I, Class B, Body mounted (relay in socket including retaining clip) |
| Shock | IEC 61373, Category I, Class B, Body mounted (relay in socket including retaining clip) |
| Operating temperature | -50 °C...+85 °C |
| Humidity | 95% (condensation is permitted temporarily) |
| Salt mist | IEC 60068-2-11, class ST4 |
| Damp heat | IEC 60068-2-30, Test method Db variant 1 |
| Protection | IEC 60529, IP40 (relay on socket) |
| Fire & smoke | NF F 16101, NF F16102, EN 45545-2 |
| Insulation materials | Cover: polycarbonate Base: polyester |



CU/CP-U300-U

Technical specifications

Dimensions (mm)

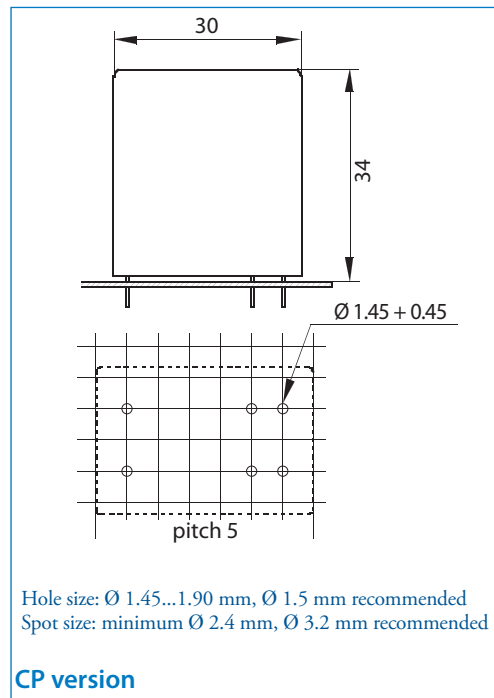
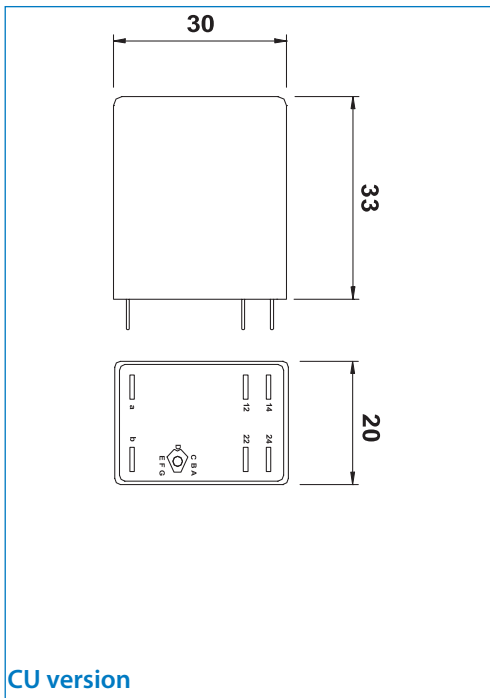

CU/CP-U300-U

Technical specifications

Options

| Code | Description | Remark | Cannot be combined with: |
|------|----------------------------------|-----------------|--------------------------|
| E * | Au; Gold plated contacts (10 µm) | | |
| Lg | Green LED | Only CU version | |
| Lr | Red LED | Only CU version | |

| | |
|--|---|
| * Gold plated contacts characteristics | |
| Material | Ag, 10 µm gold plated |
| Maximum switching voltage | 60 V (higher voltages may be possible, contact Mors Smitt for more information) |
| Maximum switching current | 400 mA (at higher rate gold will evaporate, then the standard silver contact rating of minimum 10 mA and 12 V is valid) |
| Minimum switching voltage | 5 V |
| Minimum switching current | 1 mA |

Example LED in CU relays:

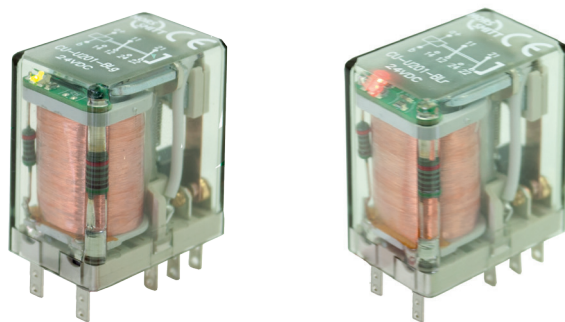

CU/CP-U300-U

Technical specifications

Switching capacity and contact life

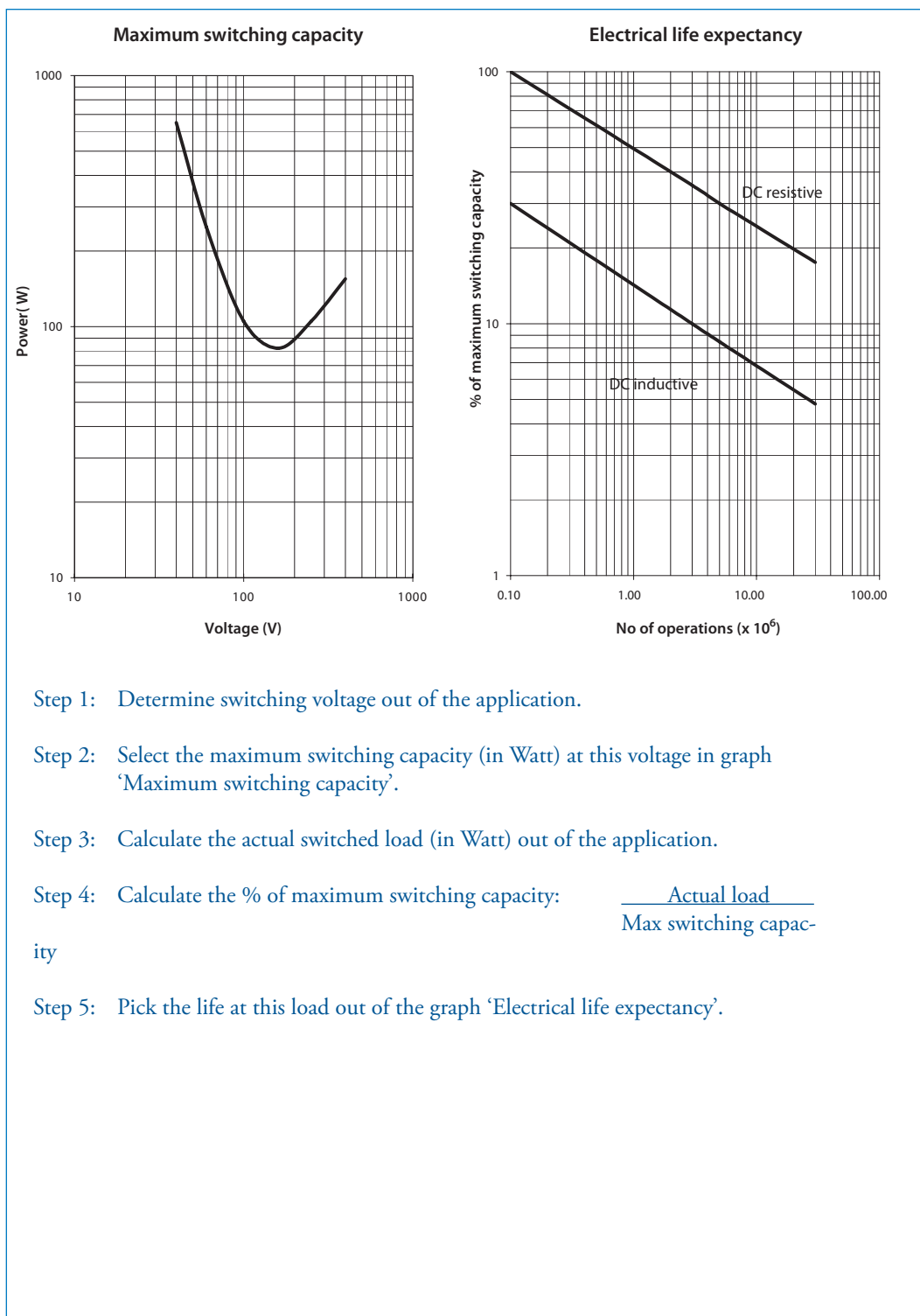

CU/CP-U300-U

Mounting possibilities / sockets

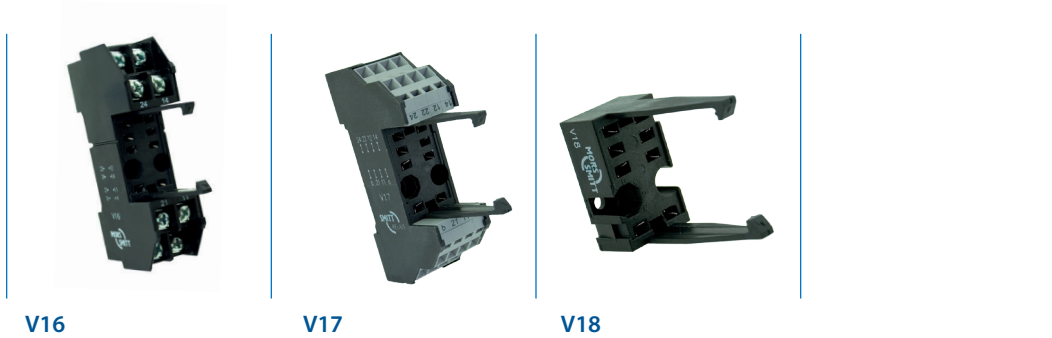

General

The CU/CP relays can be mounted in any position except with the connecting pins pointing upwards.

Relays and sockets are all tested to the IEC 61373. For rail mounting it is recommended to mount the socket with the spring side down (that means contacts 14-12-22-24 upwards).

| | | |
|-----------|-----|---|
| 338001500 | V16 | Relay socket, screw terminal, front connection |
| 338001400 | V17 | Relay socket, wall/rail mount, front connection |
| 338000620 | V18 | Relay socket, for soldering on PCB |

Optional diode /double zener diode in the socket. For details see the datasheets of the sockets on www.morssmitt.com.



CU/CP-U300-U

Keying

Mechanical keying relay and socket (optional)

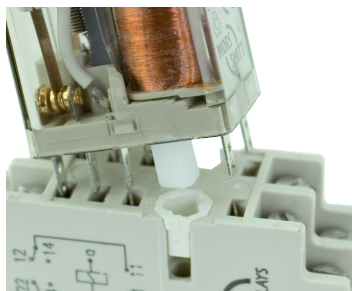

Function:

- To prevent wrong installation
- To prevent damage to equipment
- To prevent unsafe situations

Using keyed relays and sockets prevents a relay being inserted in a wrong socket. For example it prevents placing a 24 VDC relay in a 110 VDC circuit. Positive discrimination is possible per different function, coil voltage, timing, monitoring, safety and non-safety.

The CU-Series relay socket keying option gives 8 possibilities. Upon ordering the customer simply indicates the need for the optional keying. Mors Smitt will assign a code to the relay and fix the pins into the relay. The sockets are supplied with loose key receptacles. Inserting the keys into the socket is very simple and self explaining.

Remark: sockets and relay shown are only examples.

Top view socket

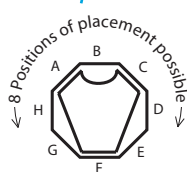
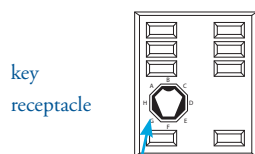

Example keying position F on socket

Bottom view relay

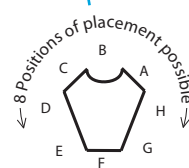
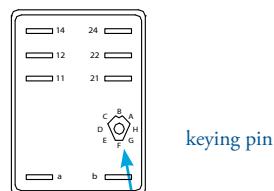

Example keying position F on relay



CU/CP-U300-U

Instructions

Installation, operation & inspection

Installation

Before installation or working on the relay: disconnect the power supply first!

Install socket and connect wiring according to the terminal identification. Plug relay into the socket ensuring there is no gap between the bottom of relay and the socket. Reverse installation into the socket is not possible due to the mechanical blocking of the standard keying inside CU relays. Check to ensure that the coil connection polarity is not reversed. Relays can be mounted tightly together to save space.

Warning!

- Never use silicon in the proximity of the relays.
- Do not use the relay in the presence of flammable gas as the arc generated from switching could cause ignition.
- To remove relays from the socket, pull the relay in a straight line out of the socket. Sideway movement may cause damage to the coil wires. When a V17 socket is used, extracting tool A171 (502110000) is required.

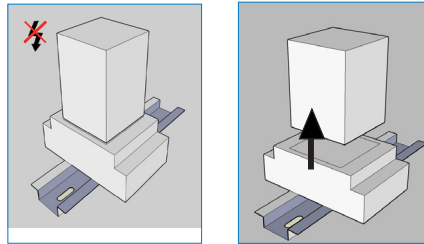

Operation

Always use the relay within its specifications. After installation always apply the rated voltage to the coil to check correct operation. Long term storage may corrode the tin plating on the relay pins. When plugging the relay into the socket, the female bifurcated receivers will automatically cut through the corrosion on the pins and guarantee a reliable connection.

Before actual use of relays, it is advised to switch the load several times with the contacts. The contacts will both be electrically and mechanically cleaned due to the positive wiping action. Sometimes a contact can build up increased contact resistance ($\leq 15 \text{ m}\Omega$ when new). When using silver contacts one can clean the contact by switching a contact load a few times using $>24 \text{ VDC}$ & $\sim 2 \text{ A}$. Increased contact resistance is not always problematic, as it depends on circuit conditions. In general a contact resistance of 1Ω is no problem, consult Mors Smitt for more information.

Condensation in the relay is possible when the coil is energised (warm) and the outside, environmental temperature is cold. This is a normal phenomenon and will not affect the function of the relay. Materials in the relay have no hygroscopic properties.

Inspection

Correct operation of the relay can easily be checked as the transparent cover provides good visibility of the moving contacts. If the relay does not seem to operate correctly, check for presence of the appropriate coil voltage and polarity using a suitable multimeter. If coil voltage is present, but the relay does not operate, a short circuit of the suppression diode if present in the socket, is possible (this may be due to the coil connection having been reversed).

If the relay doesn't work after inspection, replace the relay unit with a similar model. Do not attempt to open the relay cover or try to repair. Contacts are calibrated and in balance, touching can affect proper operation. Also re soldering may affect correct operation.

Most relay defects are caused by installation faults such as over voltage, spikes/transients, high/short current far exceeding the relay specifications. When returning the relays for investigation, please provide all information on the RMA form. Send defective relays back to the manufacturer for repair or replacement. Normal wear and tear or external causes are excluded from warranty.



CU/CP-U300-U

Ordering scheme

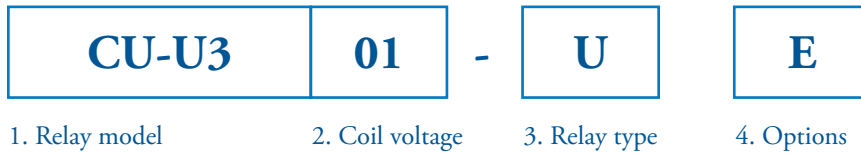

This example represents a **CU-U301-UE**.

Description: CU-U300 series relay (plug-in), U_{nom} : 24 VAC, relay type U, gold plated contacts

1. Relay model

| | |
|--------------|---------------|
| CU-U3 | Plug-in model |
| CP-U3 | PCB model |

2. Coil Voltages

| | |
|-----------|------------------|
| 01 | 24 VAC 50/60 Hz |
| 10 | 220 VAC 50/60 Hz |
| 11 | 115 VAC 50/60 Hz |

3. Relay type

| |
|----------|
| U |
|----------|

4. Options

| | |
|-----------|----------------------|
| E | Gold plated contacts |
| Lg | Green LED |
| Lr | Red LED |

Upon ordering indicate keying if necessary



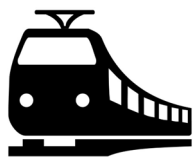

www.morssmitt.com



Mors Smitt France SAS

Tour Rosny 2, Avenue du Général de Gaulle,
F - 93118 Rosny-sous-Bois Cedex, FRANCE
T +33 (0)1 4812 1440, F +33 (0)1 4855 9001
E sales.msf@wabtec.com

Mors Smitt Asia Ltd.

29/E, Fun Towers, 35 Hung To Road
Kwun Tong, Kowloon, HONG KONG SAR
T +852 2343 5555, F +852 2343 6555
E sales.msa@wabtec.com

Mors Smitt B.V.

Vrieslantlaan 6, 3526 AA Utrecht,
NETHERLANDS
T +31 (0)30 288 1311
E sales.msby@wabtec.com

Mors Smitt Technologies Inc.

1010 Johnson Drive,
Buffalo Grove, IL 60089-6918, USA
T +1 847 777 6497, F +1 847 520 2222
E salesmst@wabtec.com

Mors Smitt UK Ltd.

Graycar Business Park, Barton under Needwood,
Burton on Trent, Staffordshire, DE13 8EN, UK
T +44 (0)1283 722650
E sales.msuk@wabtec.com

RMS Mors Smitt Ltd.

6 Anzed Court, Mulgrave,
VIC 3170, AUSTRALIA
T +61 (0)3 8544 1200 F +61 (0)3 8544 1201
E rms@rmspl.com.au