

TFBBU 400 relay - Flip flop, 4 contacts

Datasheet

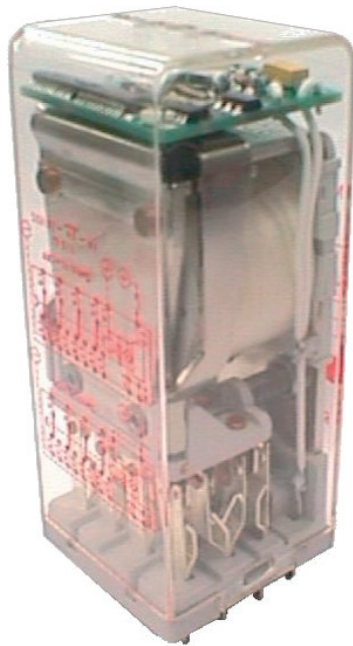

Description

The TFBBU 400 is a flip flop relay with 4 double make / double break C/O contacts (form Z). The transient pull-in mode or dropout delay is fully programmable with a dip switch and activates or deactivates the relay. The access to dip switch is available by removing time delay cover. This feature prohibits frivolous field time delay setting. Function can be also be factory set on order.

The plug-in design offers secure locking feature for maximum ease of maintenance (no wires need to be disconnected or other hardware removed for relay inspection or replacement). The resistance to impact and vibration is conform to standards in force for Railway Transported Equipment. Positive mechanical keying of relay to socket is built into relay and socket during manufacture and terminal identifications are clearly marked on identification plate that is permanently attached to the relay..

The TFBBU 400 relay is pluggable in the following sockets: EA 102 B, EA 102 BF, EA 103 BF, EA 104 B, EA 104 BF, EA 105 BF, EA 112 BF

Application

The TFBBU 400 timing relay is designed for heavy duty applications with a flip flop latching function used for example in HVAC and lighting.

Features

- Delay flip flop relay
- Transient pull-in mode or drop-out mode programmable by dip switch
- Status LED indicator
- Plug-in design with secure locking feature for maximum ease of maintenance
- 4 double make / double break C/O contacts (form Z), 12 A
- Weld no transfer contacts standard
- Contact life (mechanical) of 100 million cycles
- -40 °C...+85 °C operating temperature

Benefits

- Proven reliable in heavy duty application
- Weld no transfer
- Long life cycle
- Accurate timing selection finger safe
- Easy to maintain and replace
- Low life cycle cost
- No maintenance

Railway compliancy

- NF F 62-002 Rolling stock - Instantaneous relays contacts and sockets
- NF F 16-101/102 Fire behaviour - Railway rolling stock
- EN 50155 Railway application - Electronic equipment used on rolling stock
- IEC 61373 Railway application - shock and vibration tests



TFBBU 400 relay

Technical specifications

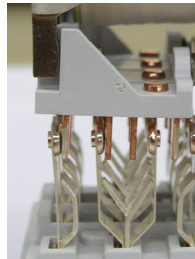

Functional and connection diagrams

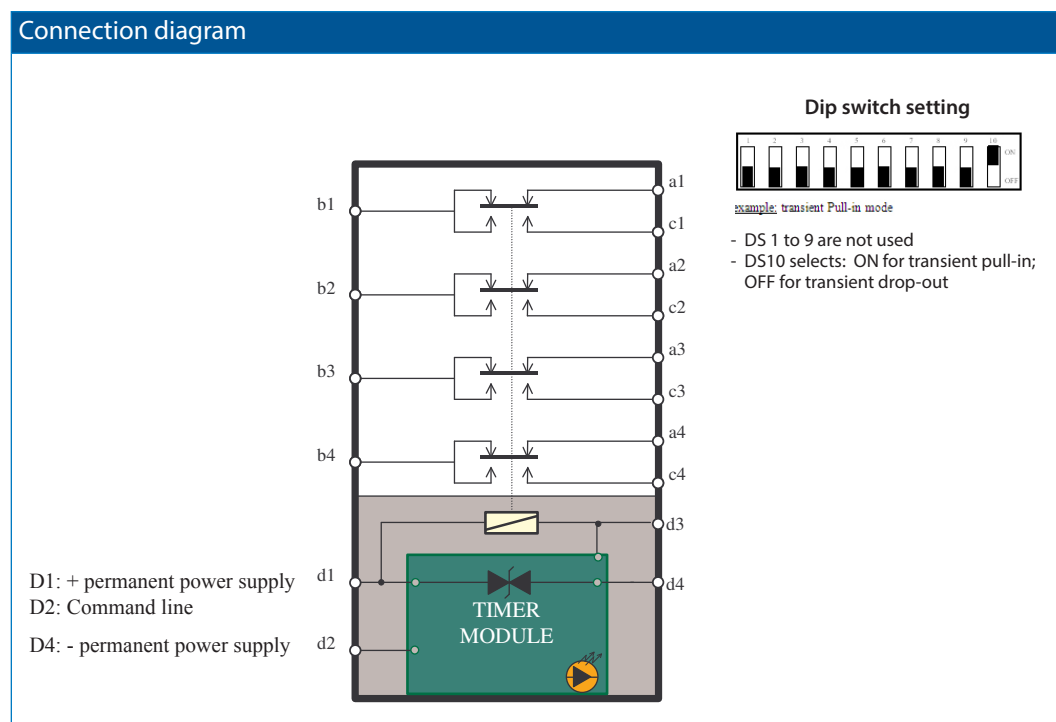
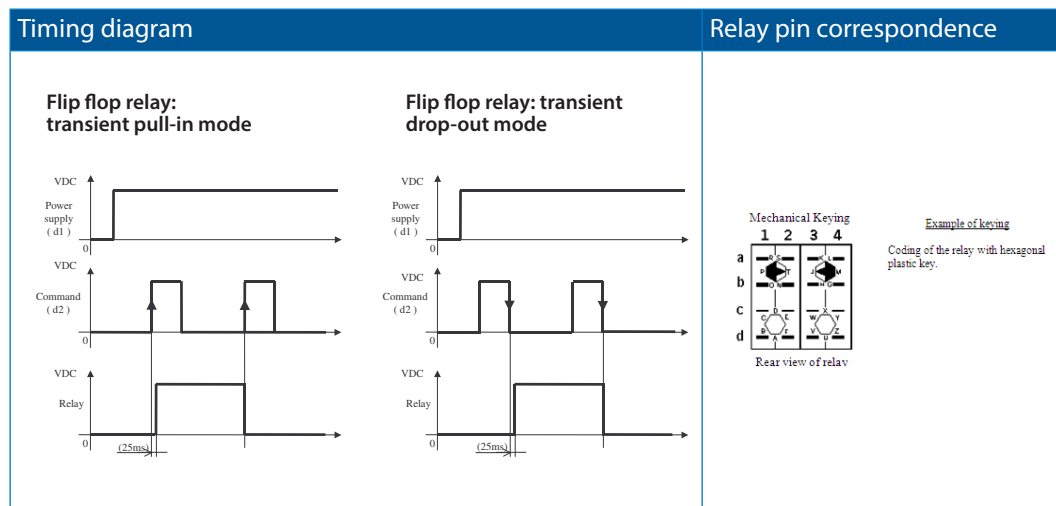

TFBBU 400 relay

Technical specifications

Timing characteristics

Time function	Flip flop relay (transient on pull-in or dropout selected by dip switch) Fixed after setting the dip switch (access available by removing relay cover)
Adjustment / repeatability accuracy	A transient command upper than 25 ms activate or deactivate the flip flop relay (Adjustment with power off)

Coil data

Keying	U _{nom} (VDC)	U _{operating} (VDC)	P _{nom} (W)	R coil (Ω) ⁽¹⁾	L/R (ms) ⁽²⁾
GV	24	16 / 33	3	185	30
XX	36	25 / 45	3	475	30
XX	48	33 / 60	3	750	30
XX	72	48 / 90	3	1700	30
XX	96	65 / 120	3	3000	30
LV	110	75 / 138	3	4000	30

(1) Coil resistance tol.: ± 8% at 20 °C

(2) Valid for closed relay

XX = to be defined

Contact data

Nominal current	12 A resistive		
Nominal breaking capacity and life	3 A at 72 VDC	L/R : 0 ms	Electrical life: 5 x 10 ⁶ op.
	1 A at 72 VDC	L/R: 30 ms	Electrical life: 2.5 x 10 ⁶ op.
	3 A at 220 VAC 50 Hz	cosØ=1	Electrical life: 2.5 x 10 ⁶ op.
	Lamp filament circuit: 200 W at 72 VDC		Electrical life: 5 x 10 ⁵ op.
Contact overload withstand	At 24 VDC: 200 A at L/R = 0 for 10 ms (10 operations at the rate of 1 operation per minute)		
Contact closure time	Pick-up time N/O < 55 ms	Drop-out* time N/C < 25 ms	
Contact opening time	Pick-up time N/C < 50 ms	Drop-out* time N/O < 15 ms	
Minimum contact continuity	20 mA at 24 VDC		
Number of contacts	4 double make / double break contacts (form Z)		
Contact material	Hard silver overlay laminated to copper		
Contact resistance	initial	10 mΩ max at 5 A	
	end of life	40 mΩ max at 5 A	



TFBBU 400 relay

Technical specifications

Contact design

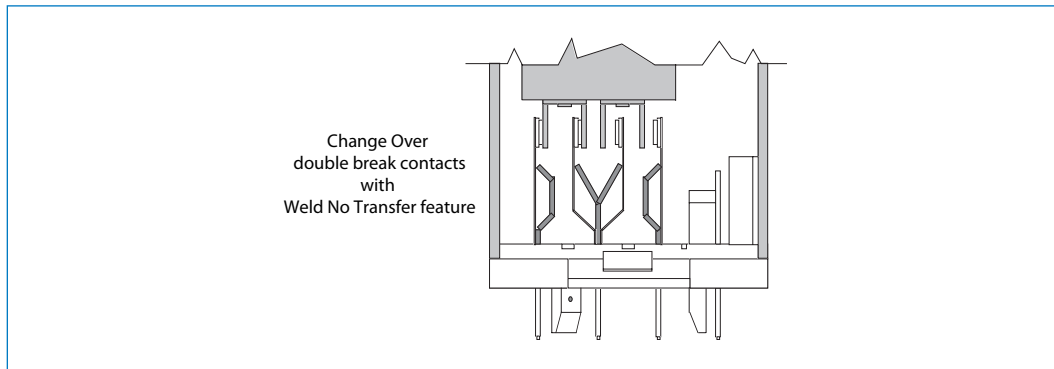

Electrical characteristics

Dielectric strength	2000 VAC, 1 min between contacts 2600 VAC, 1 min between contacts, coil and frame
Insulation resistance	≥ 1000 MΩ at 500 VDC

Mechanical & environmental characteristics

Vibration	NF F 62-002 The tests are conducted in the X, Y , Z planes at frequency between 10 & 150 cycles (sinusoidal) at 2 g IEC 61373
Shock	NF F 62-002 Tests are applied in both directions in the X, Y & Z planes. Then successive shocks are administered consisting of the positive component of sinusoidal with a value of 30 g, 11 ms IEC 61373 Other vibration and shock tests can be performed on request
Mechanical life	> 100 x 10 ⁶ operations
Weight	450 g (15.8 ounces)
Temperature	-40 °C...+85 °C
Humidity	93% RH, 40° C for 4 days
Salt mist	5% NaCl, 35° C for 4 days
Protection	IP40 (relay on socket)
Fire & smoke	Materials: Polycarbonate (cover) / polyester melamine (base) Note: These materials have been tested for fire propagation and smoke emission according standards NF F 16-101, NF F 16-102.

TFBBU 400 relay

Technical specifications

Dimensions (mm)

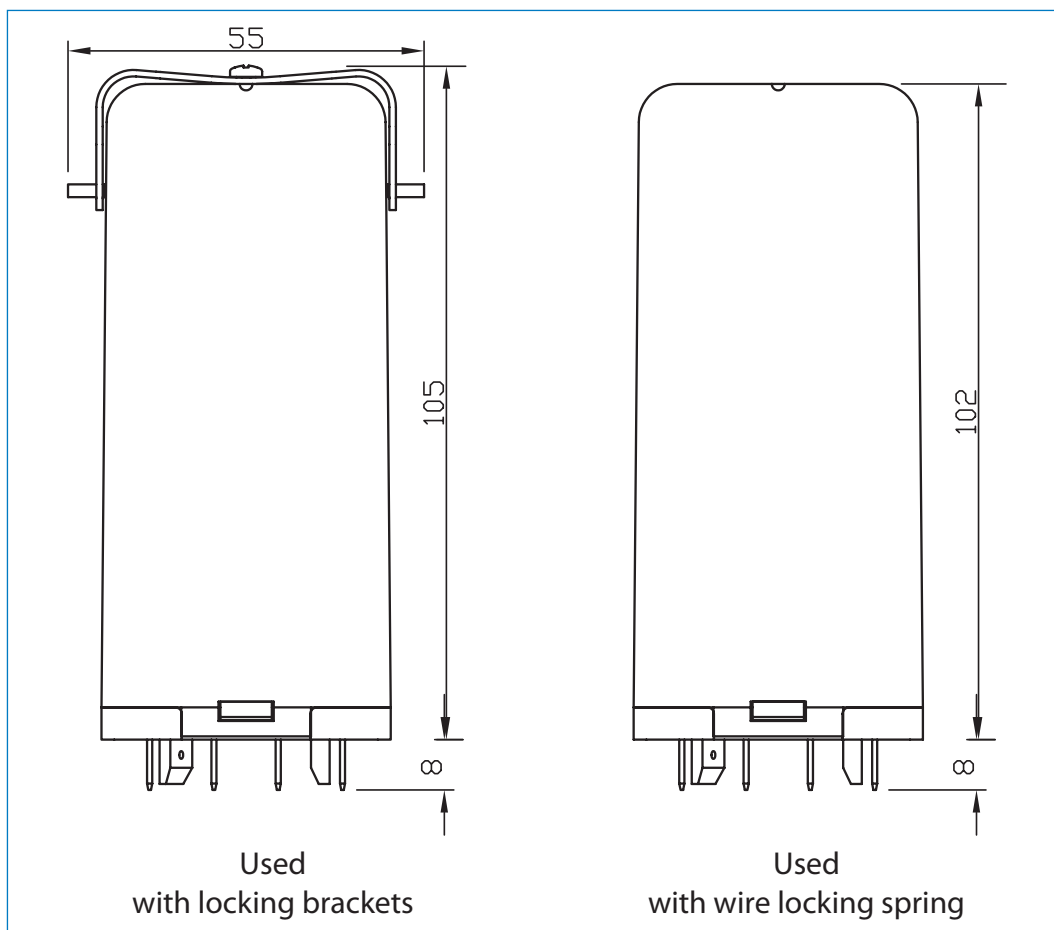

TFBBU 400 relay

Technical specifications

Dynamic relay selection curve No 1

AC Current breaking capacity versus life expectancy in millions of cycles.

Rate of contacts opening and closing = 1200 operations per hour.

Curves shown for resistive load (Power Factor = 1).

Curve	1	2	3	4
VAC	220	125	48	24

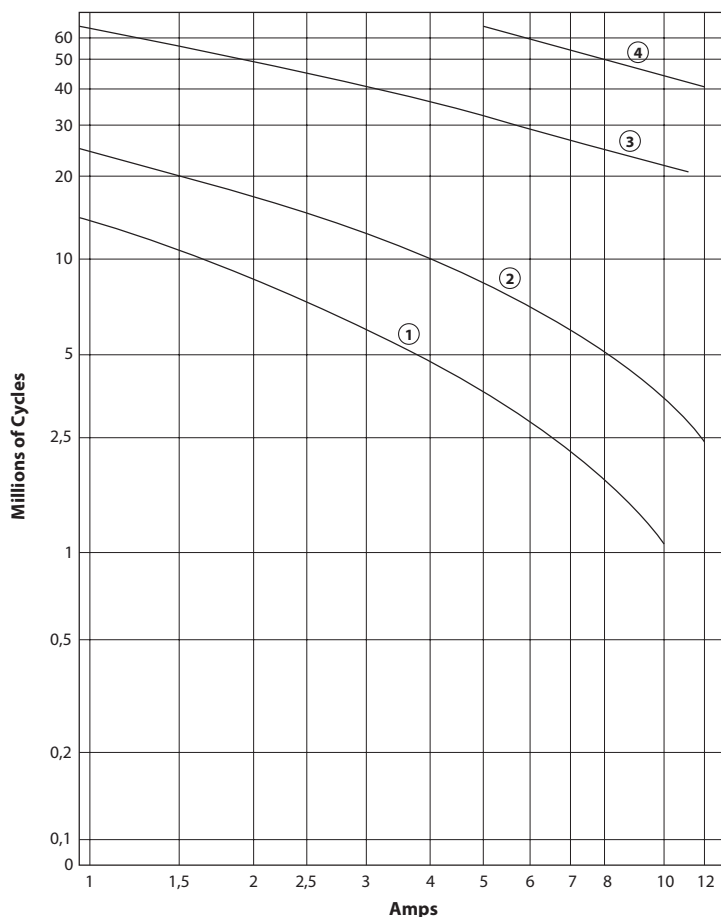

TFBBU 400 relay

Technical specifications

Dynamic relay selection curve No 2

DC Current breaking capacity versus life expectancy in millions of cycles.

Rate of contacts opening and closing = 1200 operations per hour.

Curves shown for inductive load -

—— L/R= 20 ms continuous current

- - - - L/R= 40 ms continuous current

* By connecting 2 contacts in series, DC current breaking capacity increases by 50 %

Curves	1-3	2-4	5-7	6-8
VDC	220	125	48	24

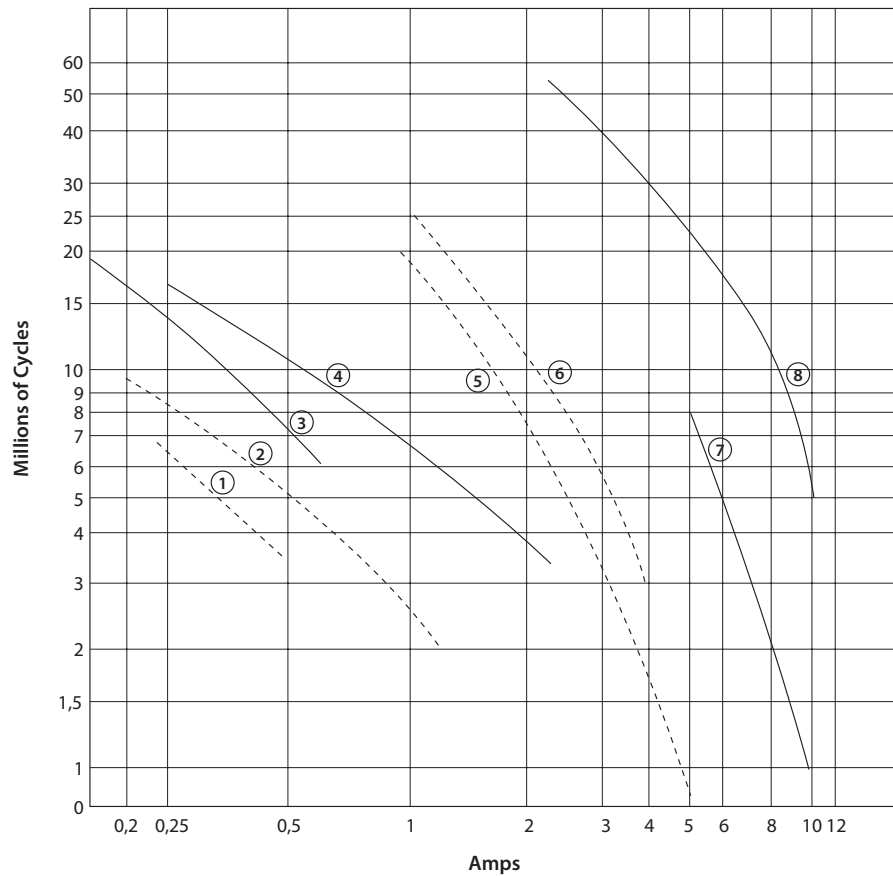

TFBBU400 relay

Technical specifications

Dynamic relay selection curve No 3

DC Current breaking capacity versus life expectancy in millions of cycles.

Rate of contacts opening and closing = 1200 operations per hour.

Curves shown for resistive load (L/R = 0). Continuous current.

* By connecting 2 contacts in series, DC current breaking capacity increases by 50 %

Curve	1	2	3	4
VDC	220	125	48	24

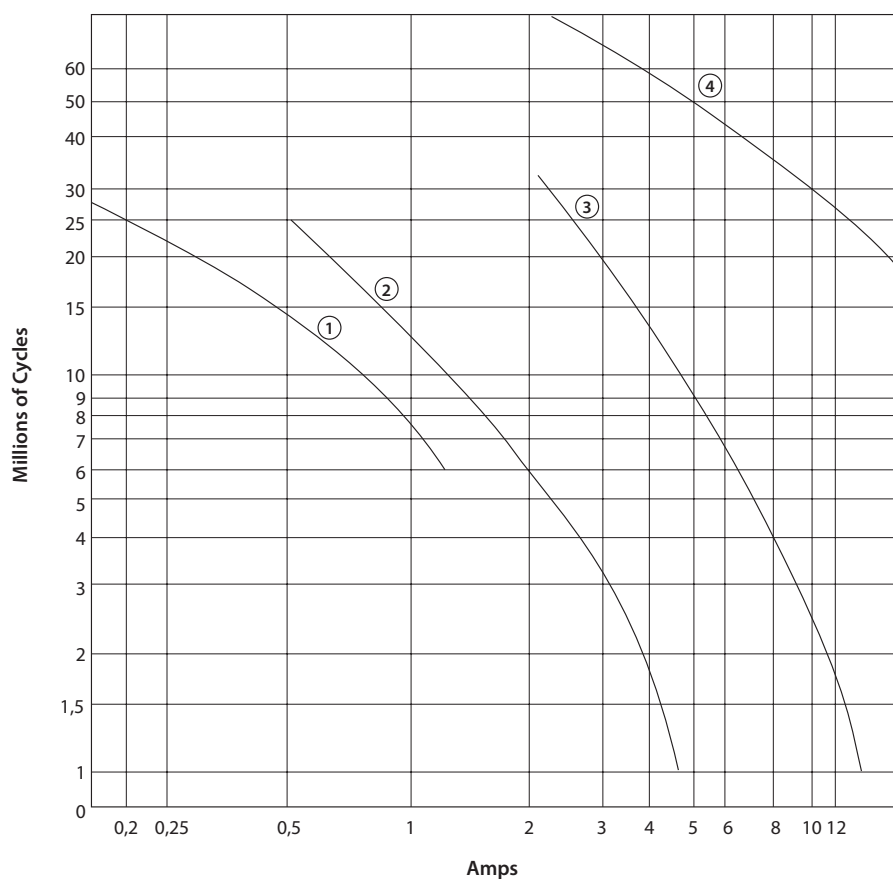

TFBBU 400 relay

Technical specifications

Dynamic relay selection curve No 4

Maximum contact breaking capacity versus voltage for a given L/R.

Rate of contacts opening and closing = 600 operations per hour.

Curves shown for resistive load (L/R=0) and inductive loads. Continuous current.

Life expectancy: 2 Millions of Cycles

Curve	1	2	3	4	5	6
L/R=	0ms	15ms	20ms	40ms	60ms	100ms

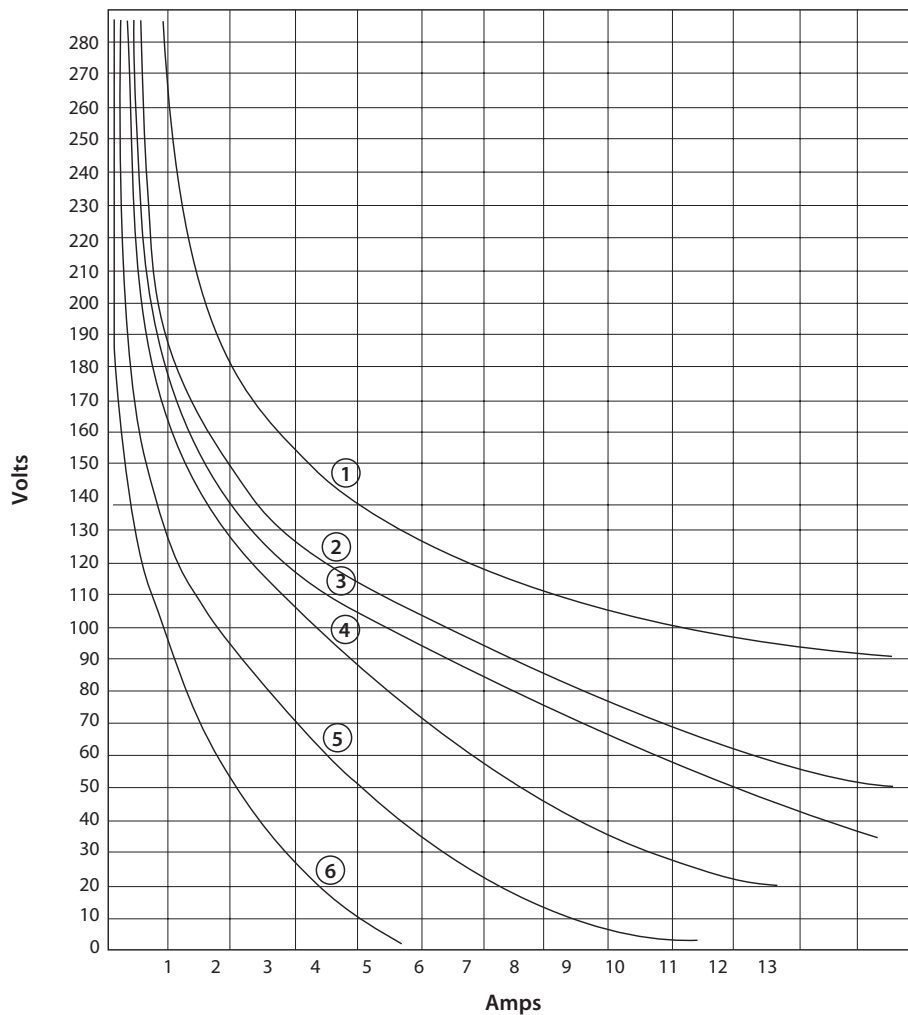

TFBBU 400 relay

Technical specifications

Dynamic relay selection curve No 5

Maximum power interruption versus load time constant (L/R) for a given voltage.
Curves shown for resistive loads. $I = P/V$.

Curve	1	2	3	4	5
VDC	220	125	72	48	24

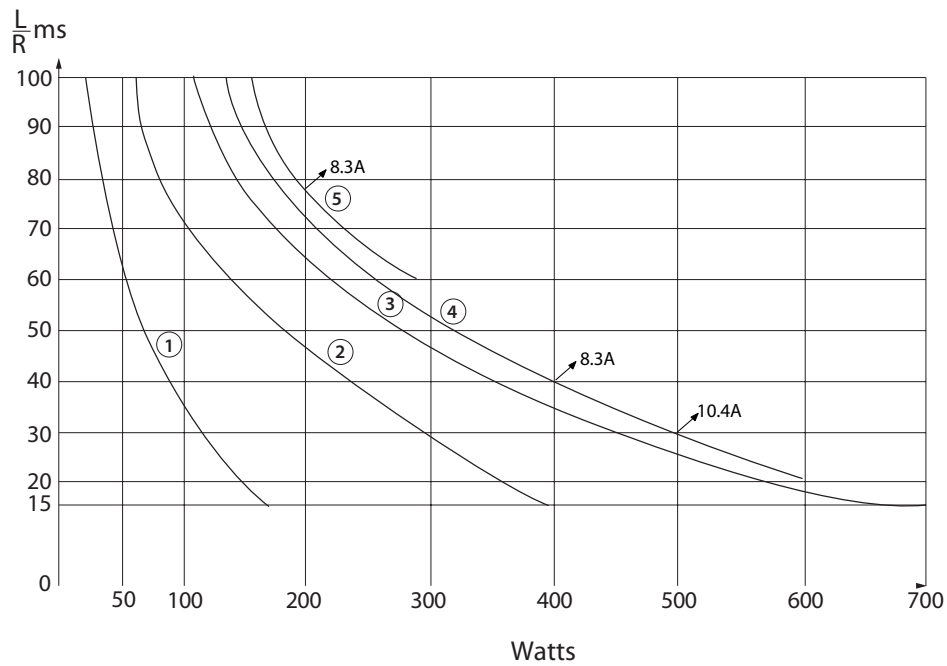

TFBBU 400 relay

Technical specifications

Dynamic relay selection curve No 6

AC Current breaking capacity versus life expectancy in millions of cycles.

Rate of contacts opening and closing = 1200 operations per hour.

Values shown for inductive loads -

——— Cos ϕ = 0.7

- - - - Cos ϕ = 0.5

- - - - Cos ϕ = 0.3

Curves	1,3 &5	2,4 &7	6,9 &10	8,11 &12
VAC	220	125	48	24

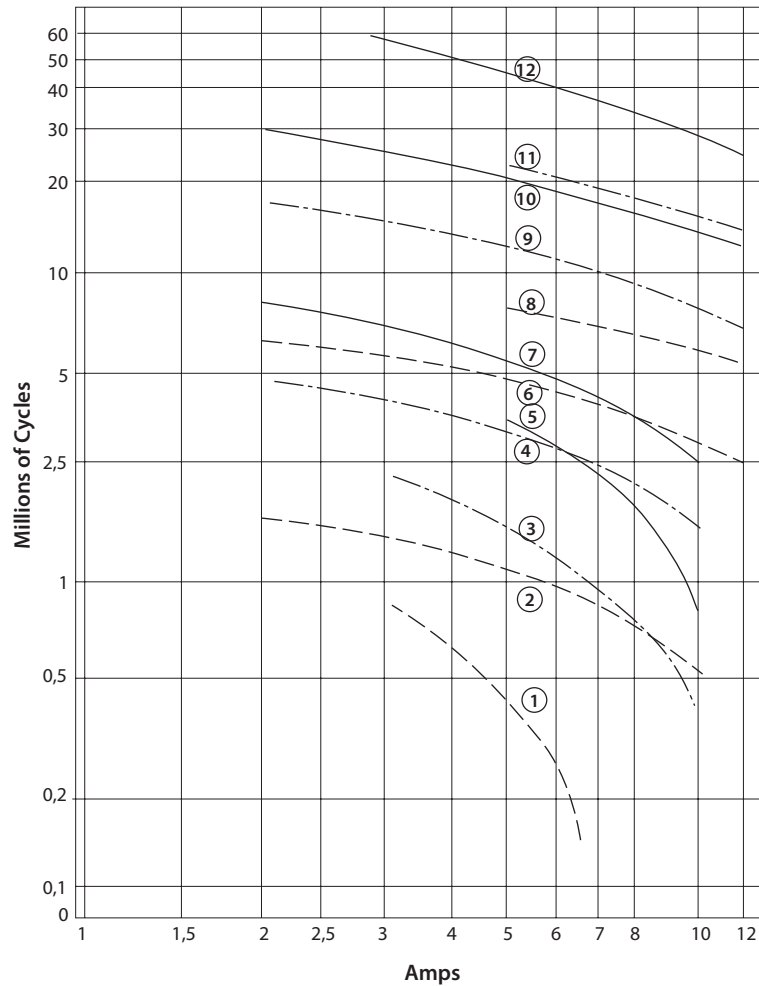

TFBBU 400 relay

Mounting possibilities / sockets

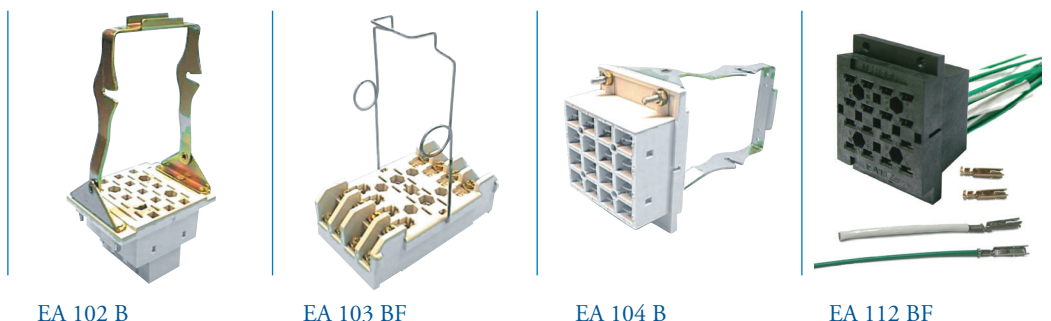

Panel/flush mounting

EA 102 B	Locking bracket (905843), rear connection, double Faston 5 mm
EA 102 BF	Wire locking spring (926853), rear connection, single Faston 5 mm
EA 104 B	Locking bracket (905843), rear connection, single Faston 5 x 0.8 mm
EA 104 BF	Wire locking spring (926853), rear connection, single Faston 5 x 0.8 mm
EA 112 BF	Wire locking spring (926853), rear connection, crimp contact

Surface/wall mounting

EA 103 BF*	Wire locking spring (926853), front connection, M3 screw 6.5 mm ring terminals (2,5 mm ²)
EA 105 BF*	Wire locking spring (926853), front connection, single Faston 5 mm









* Mounting possibility on 35 mm rail EN 50022 by adding suffix D to the part number (see socket datasheet)

Note: Keying of relay to socket can be specified by adding the keying letters in the part number. See all details in the related socket datasheet.

TFBBU 400 relay

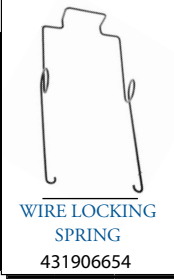
Spare parts

Spare parts - order part numbers

<p>(1)</p>  <p>LOCKING BRACKET 905846</p>	<p>(1)</p>  <p>SCREW FOR BRACKET C927210</p>	<p>(1)</p>  <p>METAL STRAP (2) P928060</p>	<p>(1)</p>  <p>METAL STRAP (4) P928061</p>
<p>(1)</p>  <p>WIRE LOCKING SPRING 431906654</p>	<p>(1)</p>  <p>ROUND PLASTIC PLUGS 414928005</p>	<p>(2)</p>  <p>HEX. PLASTIC KEYS 414905678</p>	<p>(3)</p>  <p>LOCK PINS ASSY 2 SCREWS 906364 212903020</p>

(1) Parts only for socket
 (2) Parts for relay and socket
 (3) Parts only for relay



TFBBU 400 relay

Instructions

Installation

Install socket and connect wiring correctly according identification to terminals. Plug relay into socket. Reverse installation into socket not possible due to mechanical blocking by snap-lock.

Don't reverse polarity of coil connection. Relays can be mounted (tightly) next to each other and in any attitude.

Warning! Never use silicon near by relays

Operation

Before operating always apply voltage to coil to check correct operation.

Long term storage may corrode the silver on the relay pins. Just by plugging the relay into the socket, the female bifurcated receivers will automatically clean the corrosion on the pins and guarantee a good connection.

Do not use the relay in places with flammable gas as the arc generated from switching could ignite gasses.

Maintenance

Correct operation of relay can easily be checked as transparent cover gives good visibility on the moving contacts. When the relay doesn't seem to operate correct, please check presence of coil voltage. Use a multimeter. If LED is used, coil presence should be indicated. If coil voltage is present, but the relay doesn't work, a short circuit of suppression diode is possible (The coil connection was reversed). If relay doesn't work after inspection, please replace relay unit by a similar model. Send defective relay back to manufacturer. Normal wear and tear excluded.



TFBBU 400 relay

Ordering scheme

Configuration:



1. Relay model

2. Nominal voltage

3. Keying

4. Weld no transfer

5. Cover type

This example represents a **TFBBU 400 110 LV F**.

Description: TFBBU 400 relay, U_{nom} : 110 VDC, keying LV, relay cover for wire locking spring.

1. Relay model



2 & 3. Nominal voltage and keying

24 GV	24 VDC
36 xx	36 VDC
48 xx	48 VDC
72 xx	72 VDC
96 xx	96 VDC
110 LV	110 VDC
xx = to be defined	

4. Weld no transfer



5. Relay cover type

–	Relay cover with lock pins
F	Relay cover for wire locking spring





DS-TFBBU 400-V2.1 July 2016

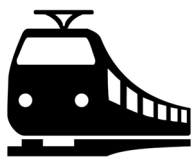

www.morssmitt.com



Mors Smitt France SAS

Tour Rosny 2, Avenue du Général de Gaulle,
F - 93118 Rosny-sous-Bois Cedex, FRANCE
T +33 (0)1 4812 1440, F +33 (0)1 4855 9001
E sales.msf@wabtec.com

Mors Smitt Asia Ltd.

29/E, Fun Towers, 35 Hung To Road
Kwun Tong, Kowloon, HONG KONG SAR
T +852 2343 5555, F +852 2343 6555
E sales.msa@wabtec.com

Mors Smitt B.V.

Vrieslantlaan 6, 3526 AA Utrecht,
NETHERLANDS
T +31 (0)30 288 1311, F +31 (0)30 289 8816
E sales.msbv@wabtec.com

Mors Smitt Technologies Inc.

1010 Johnson Drive,
Buffalo Grove, IL 60089-6918, USA
T +1 847 777 6497, F +1 847 520 2222
E salesmst@wabtec.com

Mors Smitt UK Ltd.

Graycar Business Park, Barton under Needwood,
Burton on Trent, Staffordshire, DE13 8EN, UK
T +44 (0)1283 722650 F +44 (0)1283 722651
E sales.msuk@wabtec.com

RMS Mors Smitt

6 Anzed Court, Mulgrave,
VIC 3170, AUSTRALIA
T +61 (0)3 8544 1200 F +61 (0)3 8544 1201
E sales.rms@wabtec.com

(c) Copyright 2016

All rights reserved. Nothing from this edition may be multiplied, or made public in any form or manner, either electronically, mechanically, by photocopying, recording, or in any manner, without prior written consent from Mors Smitt. This also applies to accompanying drawings and diagrams. Due to a policy of continuous development Mors Smitt reserves the right to alter the equipment specification and description outlined in this datasheet without prior notice and no part of this publication shall be deemed to be part of any contract for the equipment unless specifically referred to as an inclusion within such contract. Mors Smitt does not warrant that any of the information contained herein is complete, accurate, free from potential errors, or fit for any particular purpose. Mors Smitt does not accept any responsibility arising from any party's use of the information in this document.