

/// Plug-in railway relay with 4 C/O contacts

Rugged plug-in relays for extreme reliability, within long endurance applications and harsh environments

CTD4-U

Timer relay

Part of D-platform



Description

Plug-in electronic railway customizable timer relay with four change-over contacts. Customizable: the relay is made according to customer's requirements concerning timing diagram and delay type. Almost any timing diagram is possible: for example time delays with delay on pull-in, on drop-out or both, symmetrical or asymmetrical flashing, 1-shot, 2-shot, 3-shot etc. or a combination of all these. Delay/pulse times are adjustable with 1 or 2 lockable knobs. The relay can also be supplied with fixed delay/pulse times (no knobs).

The relay has standard four change-over contacts which work according to the timing diagram. Also 2 instantaneous change-over contacts and 2 timer change-over contacts are possible, to cover virtually all needs. Besides being activated by a voltage level, it is possible to activate the relay via a command input as well. The relay is equipped with two LEDs which indicate the presence of power supply and energizing of the coil. Also standard equipped with magnetic arc blow-out for high breaking capacity and long contact life.

The construction of the relay and choice of materials makes the CTD4-U relay suitable to withstand low and high temperatures, shock & vibrating and dry to humid environments. No external retaining clip needed as integrated 'snap-lock' will hold relay into socket under all circumstances and mounting directions.

Application

These relay series are designed for demanding rolling stock applications. The CTD4-U relay can be used in all Railway applications where a standard or non-standard timer function is necessary.

Features

- Customized timing diagram based on customers requirement
- Compact plug-in design
- 4 time delayed C/O contacts or 2 time delayed C/O contacts and 2 instantaneous C/O contacts
- Delay/pulse times adjustable with 1 or 2 lockable knobs
- Also available with fixed delay/pulse times (no knobs)
- Delay/pulse times: between 0 s...∞ (no limits)
- Magnetic arc blow-out
- Two LEDs for status indication
- Suitable for DC and AC voltage
- Flat, square and silver plated relay pins for excellent socket connection
- Wide range of sockets
- Integrated snap lock
- Transparent cover
- Optional positive mechanical keying relay to socket
- Flexibility by many options

Connection diagram

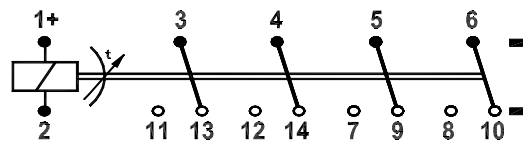

Timing diagram

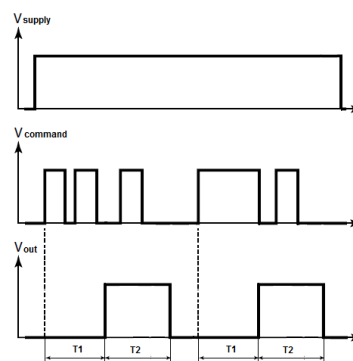

Example diagram, more on pages 3 & 4

Railway compliancy

EN 50155	EN 50121
IEC 60571	EN 45545-2
IEC 60077	NF F16-101/102
IEC 60947	NF F 62-002
IEC 61373	

Timer relay CTD4-U

Options

- Low temperature (-40 °C), max. contact current 8 A
- Gold plated contacts
- Extra dust protection
- AgSnO₂ contacts, high resistant to welding
- No magnetic arc blow-out
- Double zener diode over coil
- Double make/double break contacts
- Keying

Remark: Not all combinations possible

Dimensions (mm)

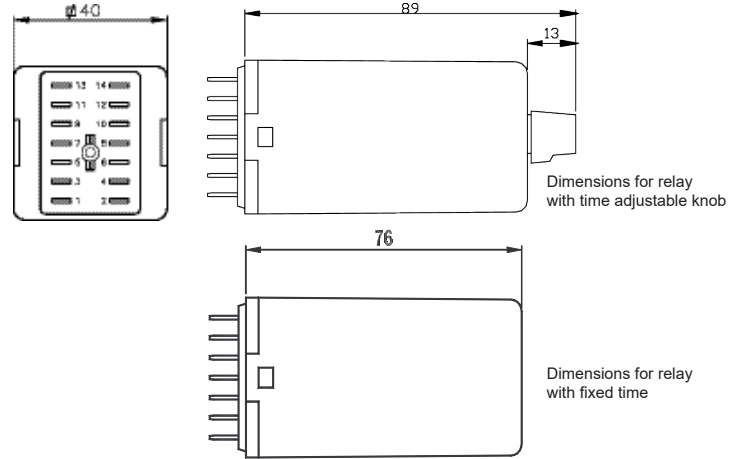

Sockets

		Mounting			
		Surface / Wall	35 mm rail	Panel / Flush	PCB
Terminal connection	Screw	V23	V23	-	-
	Screw - wide terminals	V22 BR	V23 BR	-	-
	Spring clamp	V29	V29	V33	-
	Faston	-	-	V31	-
	Crimp	-	-	V26	-
	Solder tag	-	-	V3	-
	PCB	-	-	-	V32

For more information see the respective datasheets

For more detailed technical specifications, drawings and ordering information, go to the product page on www.morssmitt.com

 **Over 10 million Mors Smitt relays in use in rail transport applications worldwide!**

Mors Smitt Asia Ltd.
 26/F., Casey Aberdeen House
 38 Heung Yip Road, Wong Chuk Hang
 Hong Kong
 Tel: +852 2343 555
sales.msa@wabtec.com

Mors Smitt France SAS
 2 Rue de la Mandinière
 72300 Sablé-sur-Sarthe, France
 Tel: +33 (0) 243 92 82 00
sales.msf@wabtec.com

Mors Smitt UK
 Graycar Business Park
 Burton on Trent, DE13 8EN, UK
 Tel: +44 (0)1283 357 263
sales.msuk@wabtec.com

Wabtec Netherlands B.V.
 Darwinstraat 10
 6718 XR Ede, Netherlands
 Tel: +31 (0)88 600 4500
sales.msbv@wabtec.com

Mors Smitt Technologies Ltd.
 1010 Johnson Drive
 Buffalo Grove, IL 60089-6918, USA
salesmst@wabtec.com

RMS Mors Smitt
 19 Southern Court
 Keysborough, VIC 3173, Australia
 Tel: +61 (0)3 8544 1200
sales.rms@wabtec.com

(c) Copyright 2022

All rights reserved. Nothing from this edition may be multiplied, or made public in any form or manner, either electronically, mechanically, by photocopying, recording, or in any manner, without prior written consent from Mors Smitt. This also applies to accompanying drawings and diagrams. Due to a policy of continuous development Mors Smitt reserves the right to alter the equipment specification and description outlined in this datasheet without prior notice and no part of any contract for the equipment unless specifically referred to as an inclusion within such contract. Mors Smitt does not warrant that any of the information contained herein is complete, accurate, free from potential errors, or fit for any particular purpose. Mors Smitt does not accept any responsibility arising from any party's use of the information in this document.

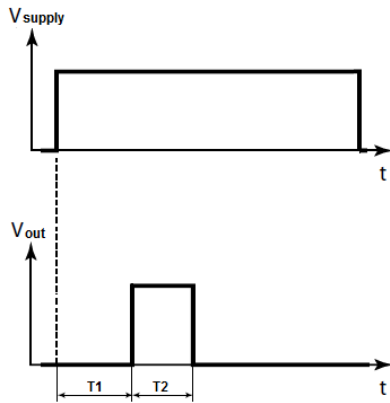
Technical specifications
Timing diagrams, examples

When supply voltage is applied, after period $T1$ the relay is activated once for period $T2$.

The relay is reset when supply voltage is removed.

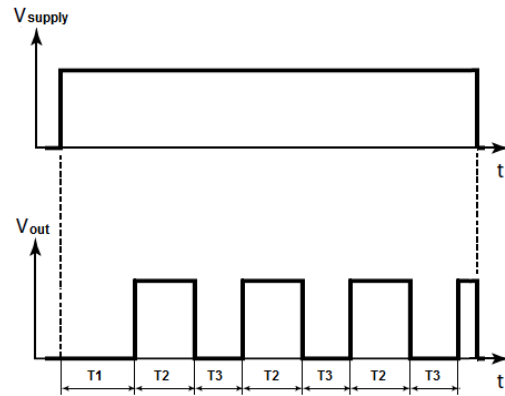

When supply voltage is applied, after period $T1$ the relay is activated for period $T2$.

After period $T3$ the relay is again activated for period $T2$, which repeats until supply voltage is removed which resets the relay.

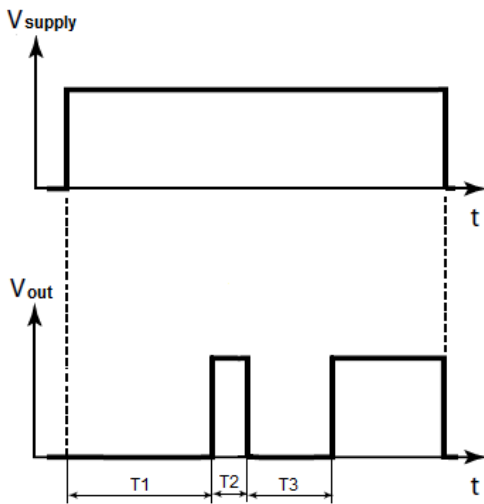

When supply voltage is applied, after period $T1$ the relay is activated for period $T2$.

After period $T3$ the relay is activated again until the supply voltage is removed, which resets the relay.

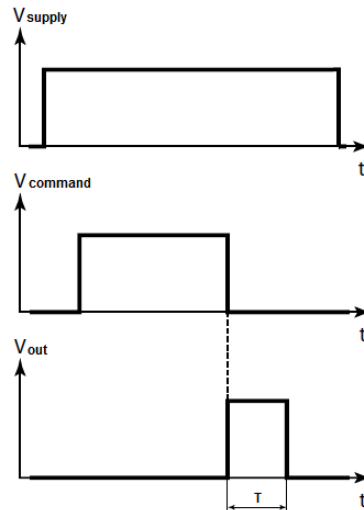

Supply voltage and command voltage is applied to the relay. The relay is activated for period T when command voltage is removed.

The relay is reset after period T or when supply voltage is removed.

Timer relay
CTD4-U

Timing diagrams, examples

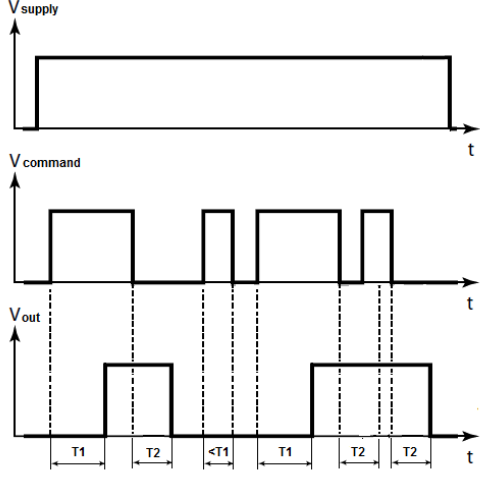

Supply voltage is applied to the relay. When command voltage is applied, after period T_1 the relay is activated if the command voltage is supplied during T_1 .

When control voltage is removed, after period T_2 the relay is de-activated unless control voltage is applied again within period T_2 .

The relay is reset after period T_2 if the relay is de-activated or when supply voltage is removed.

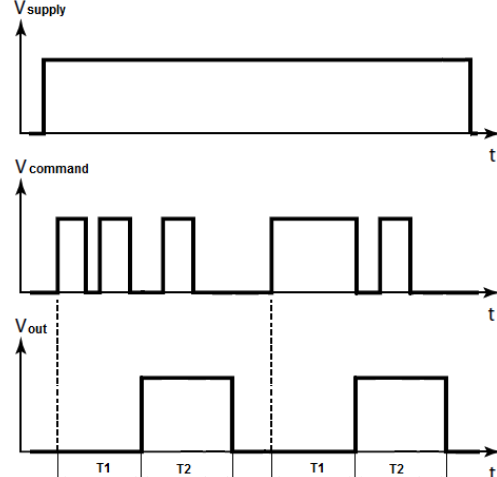

Supply voltage is applied to the relay. When command voltage is applied, after period T_1 the relay is activated for period T_2 regardless of the command voltage.

The relay is reset after period T_2 or when supply voltage is removed.

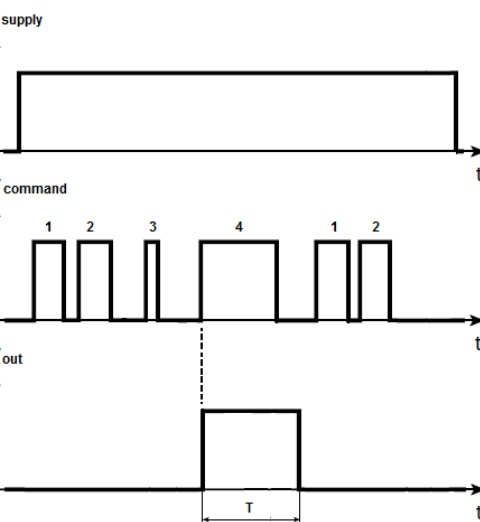

Supply voltage is applied to the relay. The 4th time a command voltage is applied regardless of the duration of the command voltage, the relay is activated for period T regardless the command voltage.

The relay is reset after period T or when supply voltage is removed.

Remarks:

1. Delay/pulse times can be adjustable or fixed; maximum 2 adjustable times possible (maximum of 2 adjustable knobs), if more times needed those must be fixed
2. Many other diagrams are possible, please contact Mors Smitt to optimize the timing diagram for your application
3. Number of change-over contacts depends on desired timing diagram

Timer relay CTD4-U

Coil characteristics

Nominal power consumption	Depends on configuration
Nominal voltages	Depends on requirements, typical any value between 24...220 VAC/DC

Type	U_{nom} (VDC)	U_{min} (VDC)	U_{max} (VDC)	$U_{drop-out}$ (VDC)
CTD4-U201	24	16.8	30	2.4
CTD4-U202	48	33.6	60	4.8
CTD4-U203	72	50.4	90	7.2
CTD4-U204	110	77.0	138	11.0
CTDA-U205	96	67.2	120	9.6
CTD4-U207	36	25.2	45	3.6

Type	U_{nom} (VAC)	Hz	U_{min} (VAC)	U_{max} (VAC)
CTD4-U301-xx	24	50	19.2	28.8
CTD4-U302-xx	220	50	176	264
CTD4-U303-xx	110	50	88	132
CTD4-U304-xx	120	60	96	144
CTD4-U305-xx	110	60	88	132
CTD4-U307-xx	115	60	92	138

Other types on request

Remarks:

- U_{min} is the must-operate voltage at which the relay has picked up in all circumstances (worst-case situation), in practice the relay picks up at a lower voltage
- Always select the nominal voltage as close as possible to the actual voltage in the application

Contact characteristics (for versions with 4 C/O contacts)

Amount and type of contacts	4 C/O
Maximum make current	16 A
Peak inrush current	NF F 62-002 200 A (withstand > 10 x 200 A @ 10 ms, 1 min)
Maximum continuous current	10 A
Maximum switching voltage	250 VDC, 440 VAC
Minimum switching voltage	12 V
Minimum switching current	10 mA
Maximum breaking capacity (> 50.000 operations)	72 VDC, 5 A (L/R ≤ 40 ms) 110 VDC, 10 A (resistive load) 110 VDC, 0.5 A (L/R ≤ 40 ms)
Contact resistance	15 mΩ (initial)
Material	Ag standard (optional AgSnO ₂ , Au on Ag)
Contact gap	0.7 mm
Contact force	> 200 mN

Remark: for configuration with 2 instantaneous and 2 timer contacts values may differ.

Timer relay CTD4-U

Electrical characteristics (for versions with 4 C/O contacts)

Dielectric strength	Pole-pole	4 kV, 50 Hz, 1 min
	Cont-coil	2.kV, 50 Hz, 1 min
	Open contacts	2.5 kV; 50 Hz; 1 min
Pulse withstanding	IEC 60255-1	5 kV (1.2/50 µs)
EMC	EN 50121-3-2	

Mechanical characteristics

Mechanical life	30 x 10 ⁶ operations
Maximum switching frequency	Mechanical: 3600 ops/h Electrical: 1200 ops/h
Torque value to lock knob	0.2-04 Nm
Weight	190 g (depending on configuration)

Environmental characteristics

Environmental	EN 50125-1
Vibration	IEC 61373, Category I, Class B, Body mounted
Shock	IEC 61373, Category I, Class B, Body mounted
Operating temperature	-25 °C...+70 °C (optional: -40 °C)
Humidity	95% (condensation is permitted temporarily)
Maximum altitude	2000 meter. Higher altitudes are possible but have consequences mentioned in IEC 60664 (for example 5000 meter with bigger clearance distance)
Salt mist	IEC 60068-2-11, class ST4
Damp heat	IEC 60068-2-30, Test method Db variant 1
Protection	IEC 60529, IP40 (relay on socket) (with option K: IP50)
Fire & smoke	NF F 16-101, NF F 16-102, EN 45545-2: HL3 for requirements R22, R23, R26
Insulation materials	Cover: polycarbonate Base: polyester

Railway compliancy

EN 50155	Railway applications - Rolling stock - Electronic equipment
IEC 60571	Railway applications - Electronic equipment used on rolling stock
IEC 60077	Railway applications - Electric equipment for rolling stock
IEC 60947	Low-voltage switchgear and controlgear
IEC 61373	Railway applications - Rolling stock equipment - Shock and vibration tests
EN 50121	Railway applications - Electromagnetic compatibility
NF F16-101/102	Railway rolling stock - Fire behavior
EN 45545-2	Railway applications - Fire protection on railway vehicles Part 2: Requirements for fire behavior of materials and components
NF F 62-002	Railway rolling stock - On-off contact relays and fixed connections

Timer relay CTD4-U

Options*

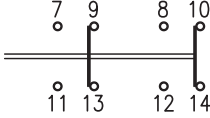
Code	Description	Remark	Cannot be combined with:
Standard options:			
C	Low temperature (-40 °C)	Icontact < 8 A	
E**	Au; Gold plated contacts (10 µm)	Yellow tape around relay for identification	M
K	Extra dust protection	IP50 Cat 2 for the relays mounted in a Mors Smitt socket. Application PD1/PD2 and contact load > 0.5 A.	
N	No magnetic arc blow-out		
Q	Double zener diode over coil	Max. allowed peak voltage 180 V, higher voltage will damage the diode	
Y	Double make/double break contacts	2 C/O DM/DB, -40 °C 	
Keying	Coil coding relay and socket		
Special options:			
M	AgSnO ₂ ; "non-weldable" contacts	Icontact > 100 mA	E

* Depending on configuration

** Gold plated contacts characteristics

Material	Ag, 10 µm gold plated
Maximum switching voltage	60 V (higher voltages may be possible, contact Mors Smitt for more information)
Maximum switching current	400 mA (at higher rate gold will evaporate, then the standard silver contact rating of minimum 10 mA and 12 V is valid)
Minimum switching voltage	5 V
Minimum switching current	1 mA

Remark: For application support or technical product support, contact your local Mors Smitt sales office (see contact details on last page).

Timer relay CTD4-U

Electrical life expectancy (for versions with 4 C/O contacts)

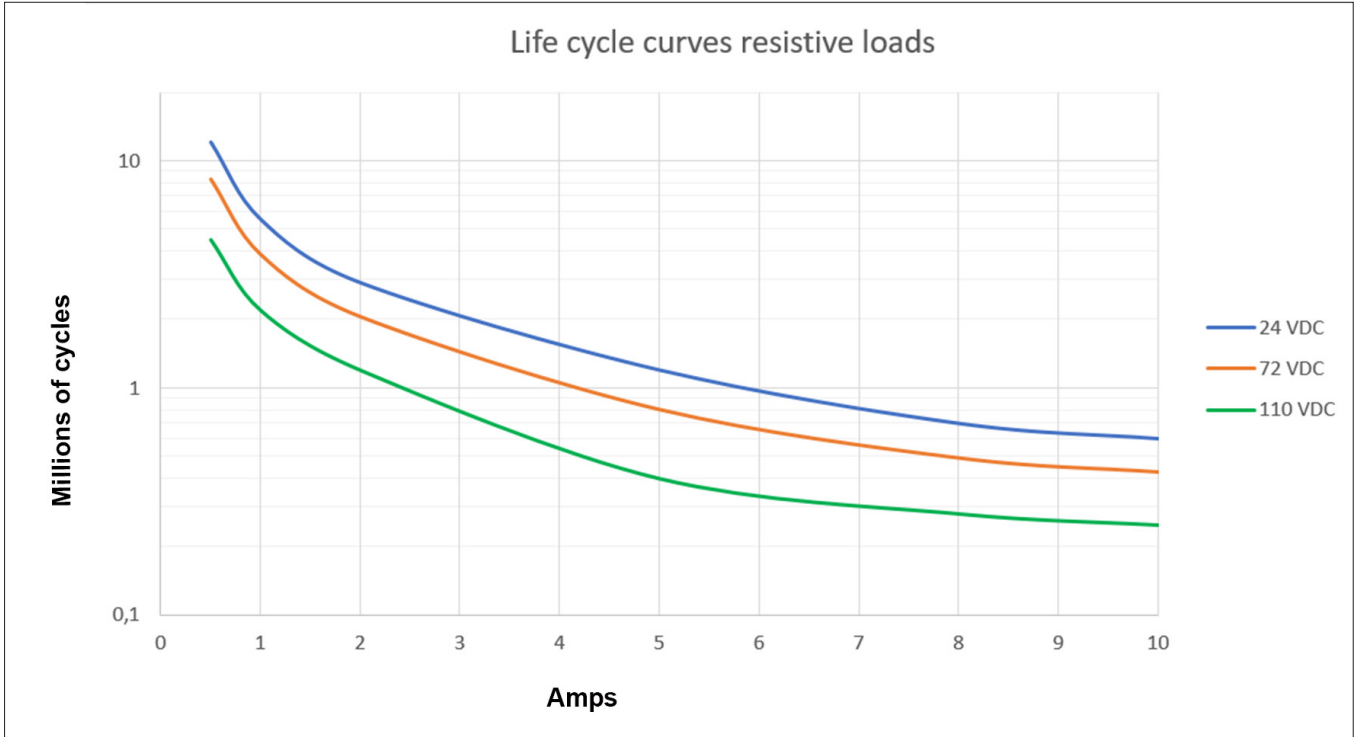

By connecting 2 contacts in series the DC current breaking capacity is increased by 50 %. Electrical lifetime is tested under laboratory conditions with switching frequency 0.33 Hz.

Note: The actual electrical lifetime in the application is affected by the switching frequency, type of contact (N/O or N/C), environmental conditions, etc.

Expected electrical lifetime inductive loads:

Inductance	Voltage	% of resistive load	Remark
15 ms	24 VDC	30 %	
15 ms	72 VDC	25 %	Tested up to 8 A
15 ms	110 VDC	20 %	Tested up to 0.5 A
40 ms	24 VDC	10 %	
40 ms	72 VDC	4 %	Tested up to 5 A
40 ms	110 VDC	2 %	Tested up to 0.5 A

For other contact loads: contact Mors Smitt.

Timer relay CTD4-U

Mounting possibilities/sockets



Surface/wall mounting

338000302	V22BR	Screw socket, wall mount, front connection (9 mm terminals)
338000580	V23	Screw socket, wall mount, front connection (7.5 mm terminals)
338000610	V29	Spring clamp socket, wall mount, front dual connection (2.5 mm ²)

Rail mounting

338000580	V23	Screw socket, rail mount, front connection (7.5 mm terminals)
338000402	V23BR	Screw socket, rail mount, front connection (9 mm terminals)
338000610	V29	Spring clamp socket, rail mount, front dual connection (2.5 mm ²)

Panel/flush mounting

338100100	V3	Solder tag socket, panel mount, rear connection
328400100	V26	Crimp contact socket, panel mount, rear connection, A260 crimp contact
338000560	V31	Faston connection socket, rear dual connection (4.8 x 0.8 mm)
338000670	V33	Push-in terminal socket, panel mount, rear dual connection (3.3 mm ²)

PCB mounting

338000561	V32	PCB soldering socket
-----------	-----	----------------------

No external retaining clip needed as the 'snap-lock' will hold the relay into the socket under all circumstances and mounting directions (according shock & vibration requirements IEC 61373, Category I, Class B, Body mounted). If regulations require external retaining clips, these are available as well.

For more details see datasheets of the sockets on www.morssmitt.com

Timer relay CTD4-U

Mechanical keying relay and socket (optional)

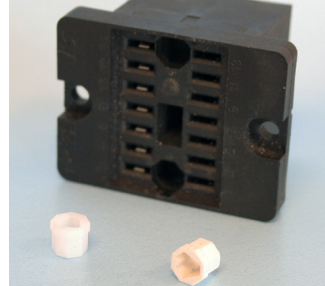

Function:

- To prevent wrong installation
- To prevent damage to equipment
- To prevent unsafe situations

Using keyed relays and sockets prevents a relay is inserted in a wrong socket. For example it prevents that a 24 VDC relay is put in a 110 VDC circuit. Positive discrimination is possible per different function, coil voltage, timing, monitoring, safety and non-safety.

The D relay socket keying option gives $8 \times 8 = 64$ possibilities. Upon ordering the customer simply indicates the need for the optional keying. Mors Smitt will assign a code to the relay and fix the pins into the relay. The sockets are supplied with loose key receptacles. Inserting the keys into the socket is very simple and self explaining.

Remark: Sockets and relay shown are examples.

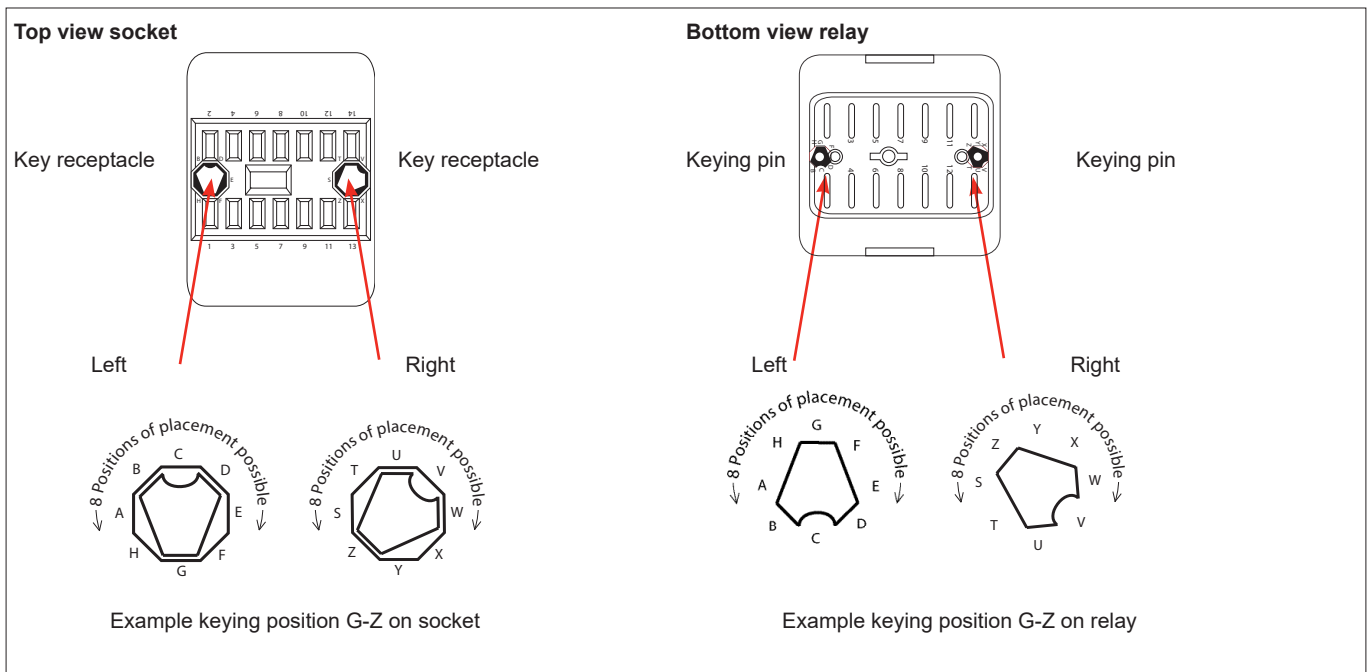

Timer relay CTD4-U

Important for relay selection and operation

Make sure the relay is suitable for the application. For critical applications (for example: green loop applications) relays should be checked on correct working during periodic inspection.

Recommendations for long time contact reliability

For relays to enable failure free performance over a very long operational time, it is important to create the right circumstances. In any relay, contact usage and atmospheric conditions influence the contact surface. To counter this effect it is common practice to use a safety factor of > 2 to ensure long time contact reliability.

Therefore for long time contact reliability we recommend:

- Silver contacts: a minimum contact current of 20 mA per contact
- Gold contacts: a minimum contact current of 10 mA per contact
- Double Make Double Break contacts: a minimum contact current of 40 mA per contact
- When low currents are switched and not frequently, e.g. 10 mA once a day, it is advised next to gold plated contacts to put similar contacts within the same relay in parallel
- With higher load switching, e.g. 110 VDC and > 1 A, put relay contacts in series
- Rule of thumb: any relay works best with switching currents > 20 mA in DC environment when frequently switched. When not switched frequently a higher switching current like 50 mA is better for a long reliable operational time
- Check relays regularly, for example with the Mors Smitt Portable Relay Tester and visually through the transparent cover

Instructions for use

Installation

Before installation or working on the relay: disconnect the power supply first (no hot swapping)! Install socket and connect wiring according to the terminal identification. Plug relay into the socket ensuring there is no gap between the bottom of relay and the socket. Reverse installation into the socket is not possible due to the mechanical blocking snap-lock feature. Check to ensure that the coil connection polarity is not reversed. Relays can be mounted tightly together to save space. When rail mounting is used, always mount the socket in the direction of the UP arrow, to have proper fixation of the socket on the rail. Torque value screw to lock knob: 0.2-0.4 Nm.

Warning!

- Never use silicon in the proximity of the relays
- Do not use the relay in the presense of flammable gas as the arc generated from switching could cause ignition
- To remove relays from the socket, employ up and down lever movements. Sideway movement may cause damage to the coil wires

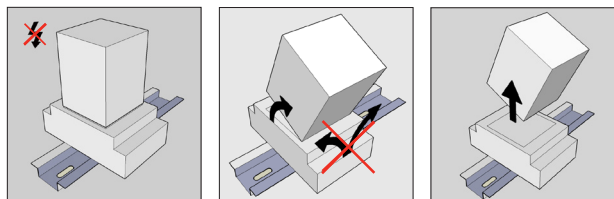

- Relays should never be swapped to other circuit positions when taken out of its socket for inspection or fault finding, always place it back into the original position to prevent contact resistance problems. Contact resistance problems can be created when swapping relays between different circuit loads due the contact wear/condition having changed during its operational life.

Operation

After installation always apply the rated voltage to the coil to check correct operation. Long term storage may corrode the silver on the relay pins. When plugging the relay into the socket, the female bifurcated or trifurcated receivers will automatically cut through the corrosion on the pins and guarantee a reliable connection.

Before actual use of relays, it is advised to switch the load several times with the contacts. The contacts will both be electrically and mechanically cleaned due to the positive wiping action. Sometimes a contact can build up increased contact resistance (≤ 15 m Ω when new). When using silver contacts one can clean the contact by switching a contact load a few times using >24 VDC & ~ 2 A. Increased contact resistance is not always problematic, as it depends on circuit conditions. In general a contact resistance of 1 Ω is no problem, consult Mors Smitt for more information.

Condensation in the relay is possible when the coil is energised (warm) and the outside, environmental temperature is cold. This is a normal phenomenon and will not affect the function of the relay. Materials in the relay have no hygroscopic properties.

Timer relay CTD4-U

Inspection / maintenance

Correct operation of the relay can easily be checked as the transparent cover provides good visibility of the moving contacts. If the relay does not seem to operate correctly, check for presence of the appropriate coil voltage and polarity using a suitable multimeter. If a LED is fitted, it indicates voltage presence to the coil. If coil voltage is present, but the relay does not operate, a short circuit of the suppression diode is possible (This may have been reversed due to the coil connection).

Relays can easily be tested with the Mors Smitt Relay Tester. More information on: www.morssmitt.com.

If the relay doesn't work after inspection, replace the relay unit with a similar model. Do not attempt to open the relay cover or try to repair. Contacts are calibrated and in balance, touching can affect proper operation. Also resoldering may affect correct operation. Since 2009 relays have tamper proof seals fitted and once broken, warranty is void.

Most relay defects are caused by installation faults such as overvoltage, spikes/transients, high/short current far exceeding the relay specifications. When returning the relays for investigation, please provide all information on the RMA form. Send defective relays back to the manufacturer for repair or replacement. Normal wear and tear or external causes are excluded from warranty.

RMA procedure see www.morssmitt.com

Timer relay
CTD4-U
Ordering scheme

CTD4-U			
Coil voltages	201		24 VDC
	207		36 VDC
	202		48 VDC
	203		72 VDC
	205		96 VDC
	204		110 VDC
	301		24 VAC, 50 Hz
	303		110 VAC, 50 Hz
	302		220 VAC, 50 Hz
	305		110 VAC, 60 Hz
	307		115 VAC, 60 Hz
	304		120 VAC, 60 Hz
Options (depending on config.) (add as many options as needed)	C		Low temperature (-40 °C) - Max contact current 8 A
	E		Gold plated contacts
	K		Extra dust protection, IP50
	N		No magnetic arc blow-out
	Q		Double zener diode
	Y		Double make/double break (-40 °C)
Special options (minimum order quantity: 20)	M		AgSnO ₂ contacts, highly resistant to welding
Ref		Customer specific configuration

Examples:

CTD4-U204-C Ref 0312

Description: CTD4 relay, Unom 110 VDC, low temperature (-40 °C), ref 0312

Timer relay
CTD4-U

 **Over 10 million Mors Smitt relays in use in rail transport applications worldwide!**

Mors Smitt Asia Ltd.
26/F., Casey Aberdeen House
38 Heung Yip Road, Wong Chuk Hang
Hong Kong
Tel: +852 2343 555
sales.msa@wabtec.com

Mors Smitt France SAS
2 Rue de la Mandinière
72300 Sablé-sur-Sarthe, France
Tel: +33 (0) 243 92 82 00
sales.msf@wabtec.com

Mors Smitt UK
Graycar Business Park
Burton on Trent, DE13 8EN, UK
Tel: +44 (0)1283 357 263
sales.msuk@wabtec.com

Wabtec Netherlands B.V.
Darwinstraat 10
6718 XR Ede, Netherlands
Tel: +31 (0)88 600 4500
sales.msbv@wabtec.com

Mors Smitt Technologies Ltd.
1010 Johnson Drive
Buffalo Grove, IL 60089-6918, USA
salesmst@wabtec.com

RMS Mors Smitt
19 Southern Court
Keysborough, VIC 3173, Australia
Tel: +61 (0)3 8544 1200
sales.rms@wabtec.com

(c) Copyright 2022

All rights reserved. Nothing from this edition may be multiplied, or made public in any form or manner, either electronically, mechanically, by photocopying, recording, or in any manner, without prior written consent from Mors Smitt. This also applies to accompanying drawings and diagrams. Due to a policy of continuous development Mors Smitt reserves the right to alter the equipment specification and description outlined in this datasheet without prior notice and no part of this publication shall be deemed to be part of any contract for the equipment unless specifically referred to as an inclusion within such contract. Mors Smitt does not warrant that any of the information contained herein is complete, accurate, free from potential errors, or fit for any particular purpose. Mors Smitt does not accept any responsibility arising from any party's use of the information in this document.