

TCBBU 400 relay - Flashing, 4 contacts

Datasheet



Description

The TCBBU 400 is a flashing relay with 4 double make / double break C/O contacts (form Z). The pulse duration is fully programmable with a dip switch from 0.25 s to 63.75 min. The access to dip switch is available by removing time delay cover. This feature prohibits frivolous field time delay setting.

The plug-in design offers secure locking feature for maximum ease of maintenance (no wires need to be disconnected or other hardware removed for relay inspection or replacement). The resistance to impact and vibration is conform to standards in force for Railway Transported Equipment.

Positive mechanical keying of relay to socket is built into relay and socket during manufacture and terminal identifications are clearly marked on identification plate that is permanently attached to the relay.

The TCBBU 400 relay is pluggable in the following sockets: EA 102 B, EA 102 BF, EA 103 BF, EA 104 B, EA 104 BF, EA 105 BF, EA 112 BF.

Application

The TCBBU 400 timing relay is designed for heavy duty applications with a programmable timing function.

Features

- Symmetrical flashing function
- Pulse duration 0.25 s...63.75 min
- Pulse duration fully programmable by dip switch
- Status LED indicator
- Plug-in design with secure locking feature for maximum ease of maintenance
- 4 double make / double break C/O contacts (form Z), 10 A
- -40 °C...+85 °C operating temperature.

Benefits

- Proven reliable in heavy duty application
- Weld no transfer
- Long life cycle
- Accurate timing selection finger safe
- Easy to maintain and replace
- Low life cycle cost
- No maintenance

Railway compliancy

- NF F 62-002 Rolling stock - Instantaneous relays contacts and sockets
- NF F 16-101/102 Fire behaviour - Railway rolling stock
- EN 50155 Railway application - Electronic equipment used on rolling stock
- IEC 61373 Railway application - shock and vibration tests



TCBBU 400 relay

Technical specifications



Functional and connection diagrams

Timing diagram	Relay pin correspondence
<p style="text-align: center;">Flashing</p>	<p style="text-align: center;">Relay pin correspondence</p> <p style="text-align: center;">Example: KN keying</p>

Connection diagram	Dip switch setting																																																											
	<ul style="list-style-type: none"> - Set DS 1 to 8 in ON or OFF position - The final duration is the sum of each individual ON value given in second if DS 9 is ON or in minute if DS 9 is OFF - DS 10 is set in ON position <table border="1"> <thead> <tr> <th rowspan="2">DS no</th> <th colspan="2">Range 1 DS 9 = ON</th> <th colspan="2">Range 2 DS 9 = OFF</th> </tr> <tr> <th>ON</th> <th>OFF</th> <th>ON</th> <th>OFF</th> </tr> </thead> <tbody> <tr> <td>DS 1</td> <td>0.25 s</td> <td>ON</td> <td>0.25 min</td> <td>ON</td> </tr> <tr> <td>DS 2</td> <td>0.50 s</td> <td>ON</td> <td>0.50 min</td> <td>ON</td> </tr> <tr> <td>DS 3</td> <td>1 s</td> <td>ON</td> <td>1 min</td> <td>ON</td> </tr> <tr> <td>DS 4</td> <td>2 s</td> <td>ON</td> <td>2 min</td> <td>ON</td> </tr> <tr> <td>DS 5</td> <td>4 s</td> <td>ON</td> <td>4 min</td> <td>ON</td> </tr> <tr> <td>DS 6</td> <td>8 s</td> <td>ON</td> <td>8 min</td> <td>ON</td> </tr> <tr> <td>DS 7</td> <td>16 s</td> <td>ON</td> <td>16 min</td> <td>ON</td> </tr> <tr> <td>DS 8</td> <td>32 s</td> <td>ON</td> <td>32 min</td> <td>ON</td> </tr> <tr> <td>DS 9</td> <td>ON</td> <td>Range 1</td> <td>OFF</td> <td>Range 2</td> </tr> <tr> <td>DS 10</td> <td>ON</td> <td></td> <td>ON</td> <td></td> </tr> </tbody> </table> <p>Example: The sample dip switch above is set to 22.5 s (pulse duration)</p>	DS no	Range 1 DS 9 = ON		Range 2 DS 9 = OFF		ON	OFF	ON	OFF	DS 1	0.25 s	ON	0.25 min	ON	DS 2	0.50 s	ON	0.50 min	ON	DS 3	1 s	ON	1 min	ON	DS 4	2 s	ON	2 min	ON	DS 5	4 s	ON	4 min	ON	DS 6	8 s	ON	8 min	ON	DS 7	16 s	ON	16 min	ON	DS 8	32 s	ON	32 min	ON	DS 9	ON	Range 1	OFF	Range 2	DS 10	ON		ON	
DS no	Range 1 DS 9 = ON		Range 2 DS 9 = OFF																																																									
	ON	OFF	ON	OFF																																																								
DS 1	0.25 s	ON	0.25 min	ON																																																								
DS 2	0.50 s	ON	0.50 min	ON																																																								
DS 3	1 s	ON	1 min	ON																																																								
DS 4	2 s	ON	2 min	ON																																																								
DS 5	4 s	ON	4 min	ON																																																								
DS 6	8 s	ON	8 min	ON																																																								
DS 7	16 s	ON	16 min	ON																																																								
DS 8	32 s	ON	32 min	ON																																																								
DS 9	ON	Range 1	OFF	Range 2																																																								
DS 10	ON		ON																																																									



TCBBU 400 relay

Technical specifications

Timing characteristics

Time function	Symmetrical flashing (duty cycle 1/2)
Total pulse duration range	0.25 s...63.75 min
Pulse delay adjustment	Fixed after setting the dip switch (access available by removing relay cover)
Adjustment / repeatability accuracy	< 2% (td > 5 s), < 10% (td=0.25 s up to 5 s) / < 0.1% (td = time delay) (Adjustment with power off)

Coil data

Keying	U _{nom} (VDC)	U _{operating} (VDC)	P _{nom} (W)	R coil (Ω) ⁽¹⁾	L/R (ms) ⁽²⁾
GN	24	16 / 33	3.5	185	30
HN	36	25 / 45	3.5	475	30
JN	48	33 / 60	3.5	750	30
KN	72	48 / 90	3.5	1700	30
MN	96	65 / 120	3.5	3000	30
LN	110	75 / 138	3.5	4000	30

(1) Coil resistance tol.: ± 8% at 20 °C

(2) Valid for closed relay

Contact data

Nominal current	10 A resistive		
Nominal breaking capacity and life	3 A at 72 VDC	L/R : 0 ms	Electrical life: 5 x 10 ⁶ op.
	1 A at 72 VDC	L/R: 30 ms	Electrical life: 2.5 x 10 ⁶ op.
	3 A at 220 VAC 50 Hz	cosØ=1	Electrical life: 2.5 x 10 ⁶ op.
	Lamp filament circuit: 200 W at 72 VDC		Electrical life: 5 x 10 ⁵ op.
Contact overload withstand	At 24 VDC: 200 A at L/R = 0 for 10 ms (10 operations at the rate of 1 operation per minute)		
Contact closure time	Pick-up time N/O < 55 ms	Drop-out* time N/C < 25 ms	
Contact opening time	Pick-up time N/C < 50 ms	Drop-out* time N/O < 15 ms	
Minimum contact continuity	20 mA at 24 VDC		
Number of contacts	4 double make / double break contacts (form Z)		
Contact material	Hard silver overlay laminated to copper		
Contact resistance	initial	10 mΩ max at 5 A	
	end of life	40 mΩ max at 5 A	



TCBBU 400 relay

Technical specifications

Contact design

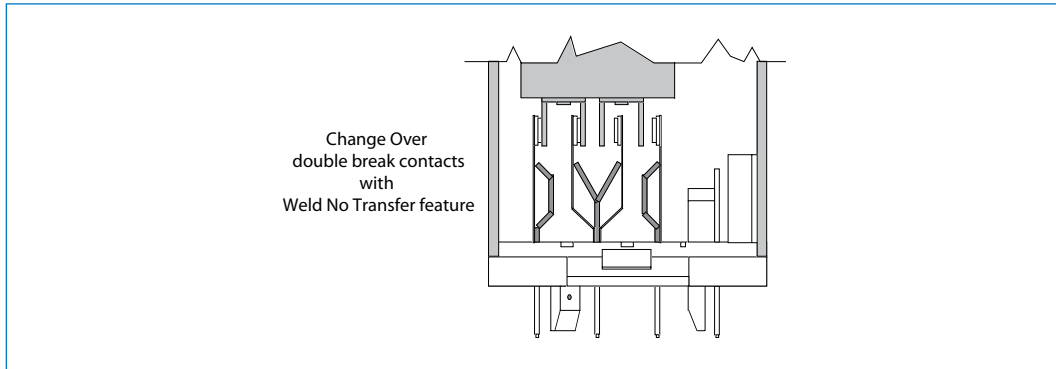

Electrical characteristics

Dielectric strength	2000 VAC, 1 min between contacts 2600 VAC, 1 min between contacts, coil and frame
Insulation resistance	≥ 1000 MΩ at 500 VDC

Mechanical & environmental characteristics

Vibration	NF F 62-002 The tests are conducted in the X, Y , Z planes at frequency between 10 & 150 cycles (sinusoidal) at 2 g IEC 61373
Shock	NF F 62-002 Tests are applied in both directions in the X, Y & Z planes. Then successive shocks are administered consisting of the positive component of sinusoidal with a value of 30 g, 11 ms IEC 61373 Other vibration and shock tests can be performed on request
Mechanical life	> 100 x 10 ⁶ operations
Weight	450 g (15.8 ounces)
Temperature	-40 °C...+85 °C
Humidity	93% RH, 40° C for 4 days
Salt mist	5% NaCl, 35° C for 4 days
Protection	IP40 (relay on socket)
Fire & smoke	Materials: Polycarbonate (cover) / polyester melamine (base) Note: These materials have been tested for fire propagation and smoke emission according standards NF F 16-101, NF F 16-102.



TCBBU 400 relay

Technical specifications

Dimensions (mm)

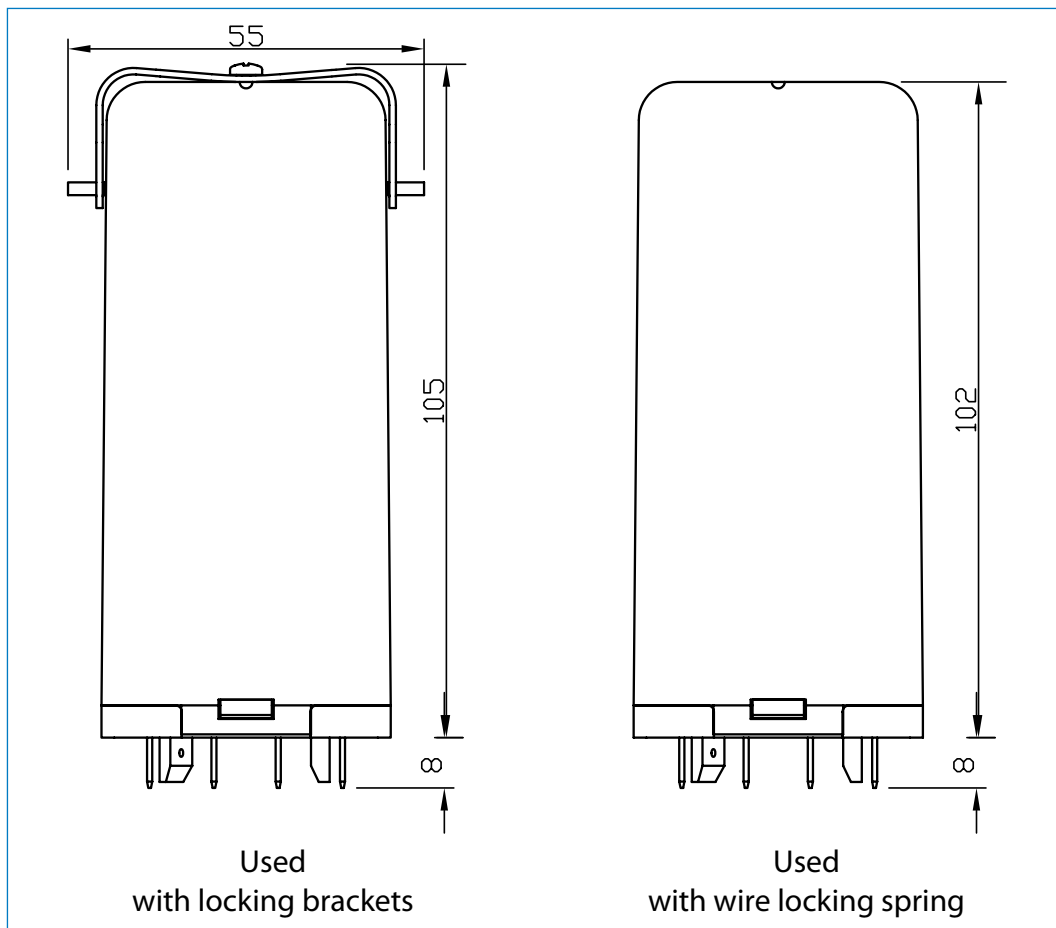

TCBBU 400 relay

Technical specifications

Dynamic relay selection curve No 1

AC Current breaking capacity versus life expectancy in millions of cycles.

Rate of contacts opening and closing = 1200 operations per hour.

Curves shown for resistive load (Power Factor = 1).

Curve	1	2	3	4
VAC	220	125	48	24

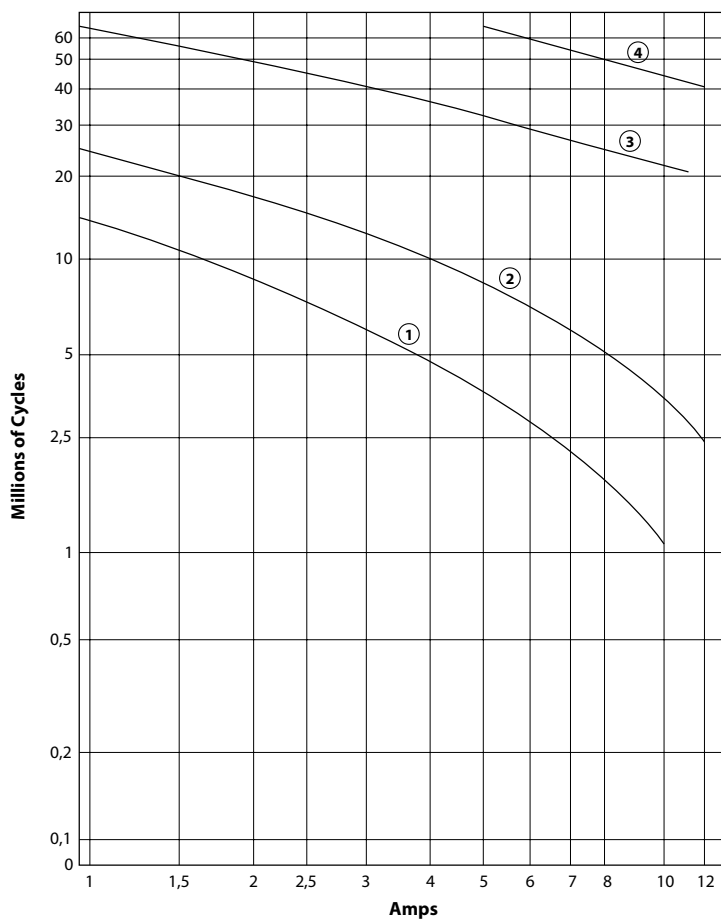

TCBBU 400 relay

Technical specifications

Dynamic relay selection curve No 2

DC Current breaking capacity versus life expectancy in millions of cycles.

Rate of contacts opening and closing = 1200 operations per hour.

Curves shown for inductive load -

—— L/R= 20 ms continuous current

- - - - L/R= 40 ms continuous current

* By connecting 2 contacts in series, DC current breaking capacity increases by 50 %

Curves	1-3	2-4	5-7	6-8
VDC	220	125	48	24

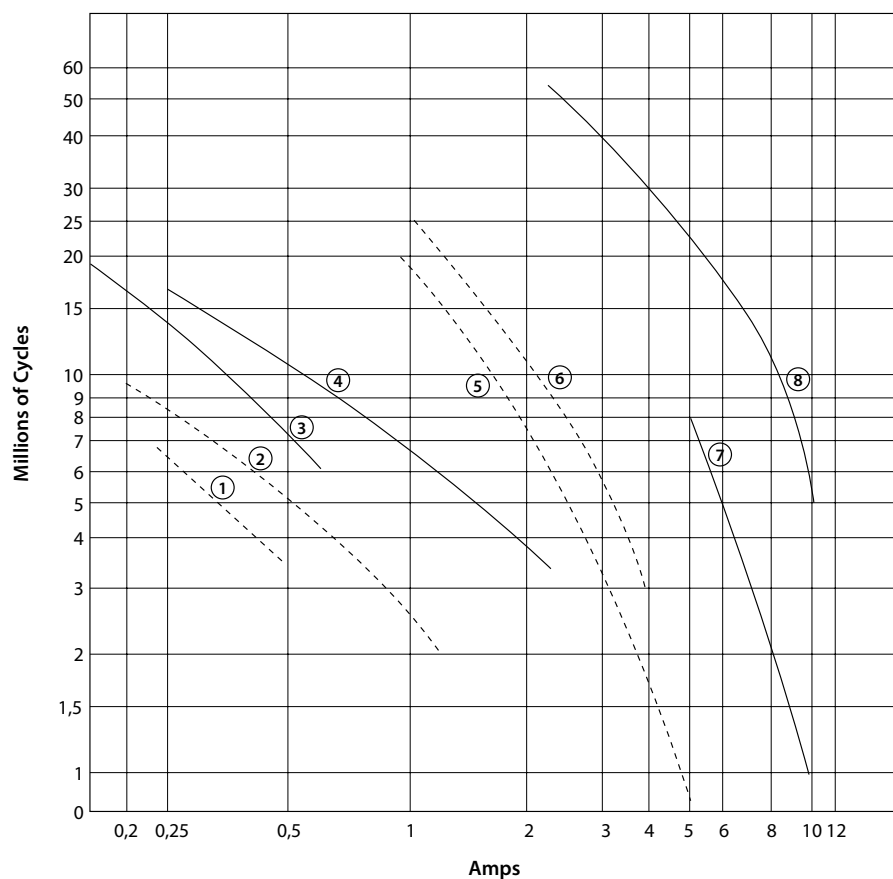

TCBBU 400 relay

Technical specifications

Dynamic relay selection curve No 3

DC Current breaking capacity versus life expectancy in millions of cycles.

Rate of contacts opening and closing = 1200 operations per hour.

Curves shown for resistive load (L/R = 0). Continuous current.

* By connecting 2 contacts in series, DC current breaking capacity increases by 50 %

Curve	1	2	3	4
VDC	220	125	48	24

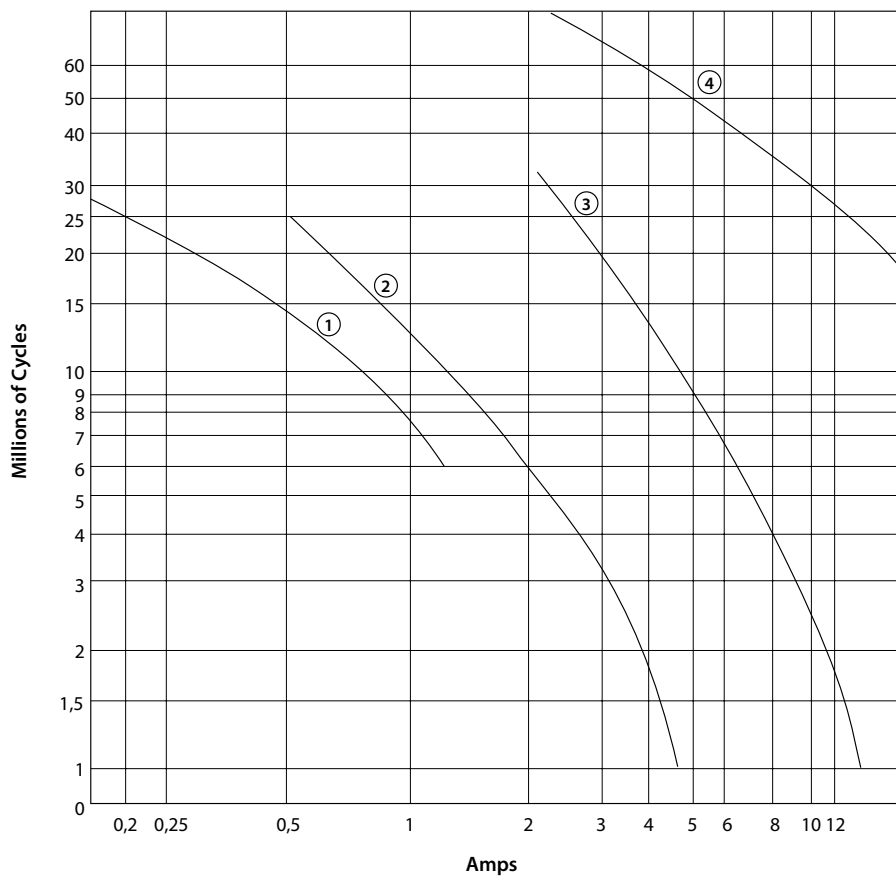

TCBBU 400 relay

Technical specifications

Dynamic relay selection curve No 4

Maximum contact breaking capacity versus voltage for a given L/R.

Rate of contacts opening and closing = 600 operations per hour.

Curves shown for resistive load (L/R=0) and inductive loads. Continuous current.

Life expectancy: 2 Millions of Cycles

Curve	1	2	3	4	5	6
L/R=	0ms	15ms	20ms	40ms	60ms	100ms

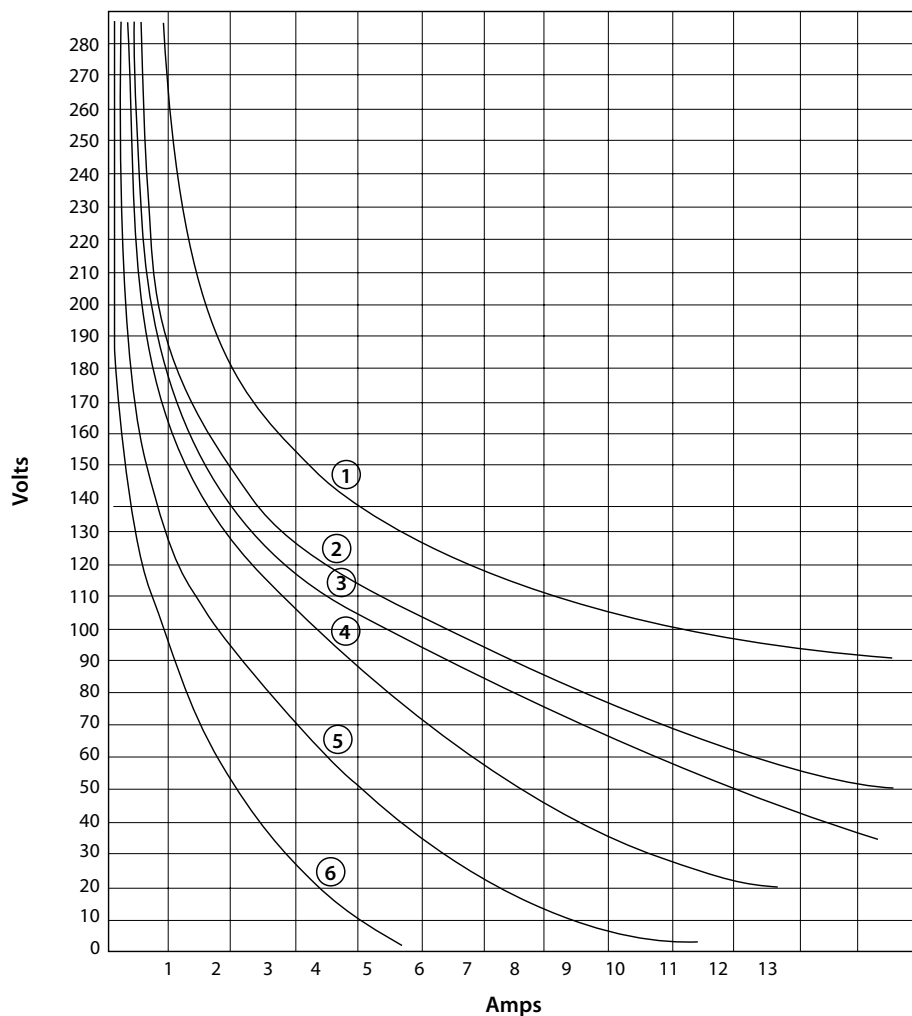

TCBBU 400 relay

Technical specifications

Dynamic relay selection curve No 5

Maximum power interruption versus load time constant (L/R) for a given voltage.
Curves shown for resistive loads. $I = P/V$.

Curve	1	2	3	4	5
VDC	220	125	72	48	24

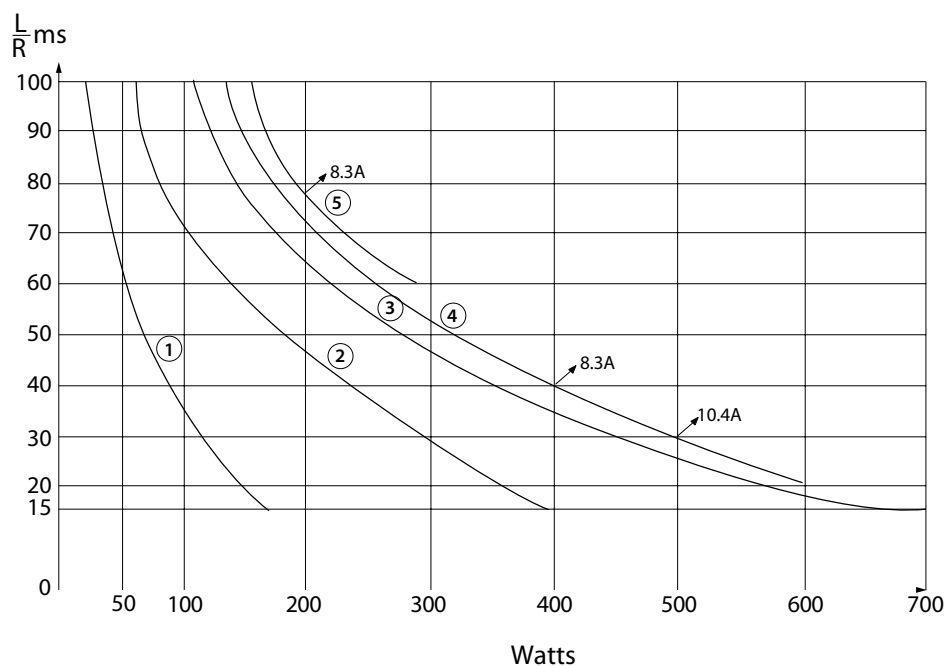

TCBBU 400 relay

Technical specifications

Dynamic relay selection curve No 6

AC Current breaking capacity versus life expectancy in millions of cycles.

Rate of contacts opening and closing = 1200 operations per hour.

Values shown for inductive loads -

- Cos ϕ = 0.7
- - - - Cos ϕ = 0.5
- - - - Cos ϕ = 0.3

Curves	1,3 &5	2,4 &7	6,9 &10	8,11 &12
VAC	220	125	48	24

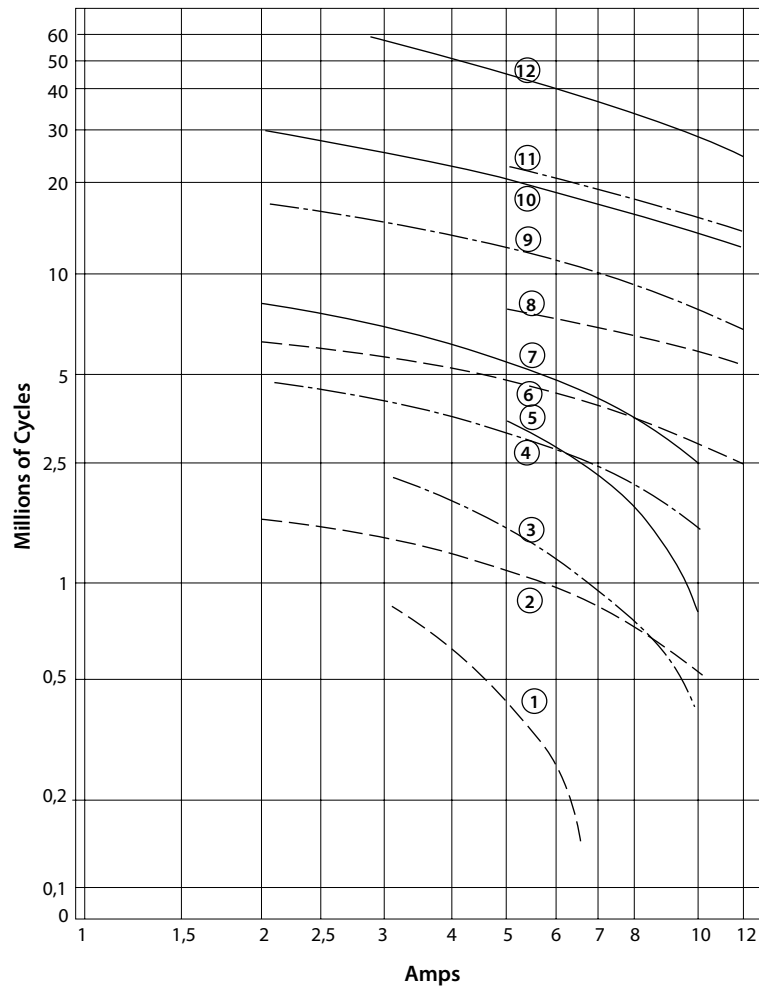

TCBBU 400 relay

Mounting possibilities / sockets

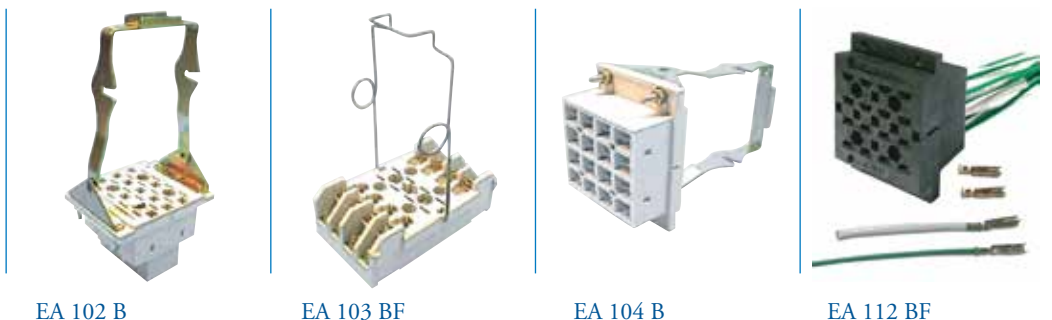

EA 102 B

EA 103 BF

EA 104 B

EA 112 BF

Panel/flush mounting

EA 102 B	Locking bracket (905843), rear connection, double Faston 5 mm
EA 102 BF	Wire locking spring (926853), rear connection, single Faston 5 mm
EA 104 B	Locking bracket (905843), rear connection, single Faston 5 x 0.8 mm
EA 104 BF	Wire locking spring (926853), rear connection, single Faston 5 x 0.8mm
EA 112 BF	Wire locking spring (926853), rear connection, crimp contact

Surface/wall mounting

EA 103 BF*	Wire locking spring (926853), front connection, M3 screw 6.5 mm ring terminals (2,5 mm ²)
EA 105 BF*	Wire locking spring (926853), front connection, single Faston 5 mm









* Mounting possibility on 35 mm rail EN 50022 by adding suffix D to the part number (see socket datasheet)

Note: Keying of relay to socket can be specified by adding the keying letters in the part number. See all details in the related socket datasheet.

TCBBU 400 relay

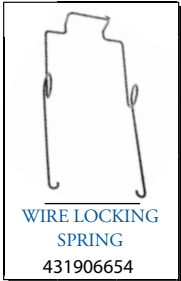
Spare parts

Spare parts - order part numbers

(1)  LOCKING BRACKET 905846	(1)  SCREW FOR BRACKET C927210	(1)  METAL STRAP (2) P928060	(1)  METAL STRAP (4) P928061
(1)  WIRE LOCKING SPRING 431906654	(1)  ROUND PLASTIC PLUGS 414928005	(2)  HEX. PLASTIC KEYS 414905678	(3)  LOCK PINS ASSY 2 SCREWS 906364 212903020

(1) Parts only for socket
 (2) Parts for relay and socket
 (3) Parts only for relay



TCBBU 400 relay

Instructions

Installation

Install socket and connect wiring correctly according identification to terminals. Plug relay into socket. Reverse installation into socket not possible due to mechanical blocking by snap-lock.

Don't reverse polarity of coil connection. Relays can be mounted (tightly) next to each other and in any attitude.

Warning! Never use silicon near by relays

Operation

Before operating always apply voltage to coil to check correct operation.

Long term storage may corrode the silver on the relay pins. Just by plugging the relay into the socket, the female bifurcated receivers will automatically clean the corrosion on the pins and guarantee a good connection.

Do not use the relay in places with flammable gas as the arc generated from switching could ignite gasses.

Maintenance

Correct operation of relay can easily be checked as transparent cover gives good visibility on the moving contacts. When the relay doesn't seem to operate correct, please check presence of coil voltage. Use a multimeter. If LED is used, coil presence should be indicated. If coil voltage is present, but the relay doesn't work, a short circuit of suppression diode is possible (The coil connection was reversed). If relay doesn't work after inspection, please replace relay unit by a similar model. Send defective relay back to manufacturer. Normal wear and tear excluded.



TCBBU 400 relay

Ordering scheme

Configuration:

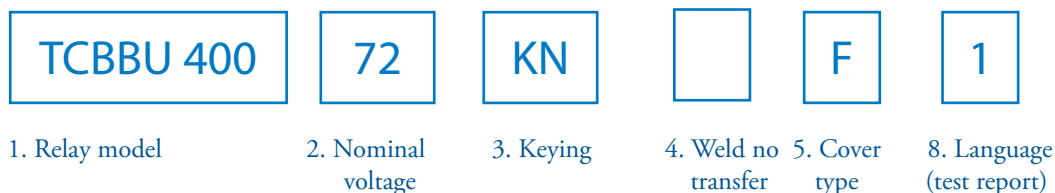

This example represents a **TCBBU 400 72 KN F 1**.

Description: TCBBU 400 relay, U_{nom} : 72 VDC, keying KN, weld no transfer, relay cover for wire locking spring, test report in English

1. Relay model

TCBBU 400

2 & 3. Nominal voltage and keying

24 GD	24 VDC
36 HN	36 VDC
48 JN	48 VDC
72 KN	72 VDC
96 MN	96 VDC
110 LN	110 VDC

4. Weld no transfer

Weld no transfer

5. Relay cover type

–	Relay cover with lock pins
F	Relay cover for wire locking spring

6. Language on test report

–	French
1	English
2	Spanish





Mors Smitt France SAS

Tour Rosny 2, Avenue du Général de Gaulle,
F - 93118 Rosny-sous-Bois Cedex, FRANCE
T +33 (0)1 4812 1440, F +33 (0)1 4855 9001
E sales@msrelais.com

Mors Smitt Asia Ltd.

807, Billion Trade Centre, 31 Hung To Road
Kwun Tong, Kowloon, HONG KONG SAR
T +852 2343 5555, F +852 2343 6555
E info@morssmitt.hk

Mors Smitt B.V.

Vrieslantlaan 6, 3526 AA Utrecht,
NETHERLANDS
T +31 (0)30 288 1311, F +31 (0)30 289 8816
E sales@nieaf-smitt.nl

Mors Smitt Technologies Inc.

420 Sackett Point Road
North Haven, CT 06473, USA
T +1 (203) 287 8858, F +1 (888) 287 8852
E mstechnologies@msrelais.com

Mors Smitt UK Ltd.

Doulton Road, Cradley Heath
West Midlands, B64 5QB, UK
T +44 (0)1384 567 755, F +44 (0)1384 567 710
E info@morssmitt.co.uk